

Rollease Automate Top Down Bottom Up Cellular Shades

- Installation and User Guide

Installation

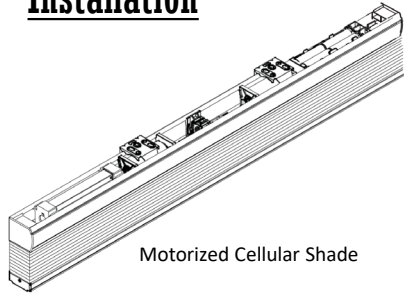

Rechargeable battery pack (includes a charge block and a 156" USB charge cable)

IDENTIFY YOUR CELLULAR SHADE AND PARTS

your parts may vary, depending on the custom request, size of the shade, and size of the headrail you are purchasing.

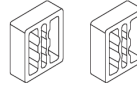
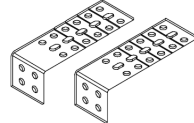
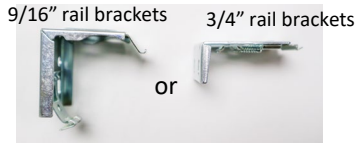

Reloadable battery tube (includes 8 AA batteries)

2 sets of reloadable battery tube or rechargeable battery pack

TOOLS AND PARTS YOU MAY NEED (not included)

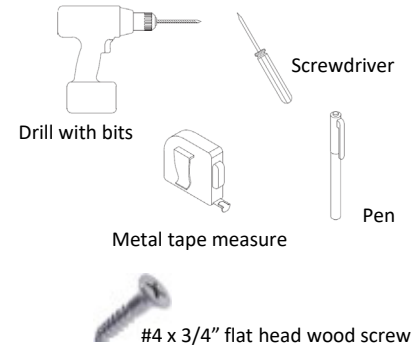

Shade width	Qty of brackets
W ≤ 36"	2
36" < W ≤ 72"	3
72" < W ≤ 96"	4
96" < W ≤ 120"	5

FOR THE 3/4" RAIL BRACKETS

1. Install the brackets

- Mark the bracket locations, separating the brackets evenly. Make sure all brackets are aligned and level with each other.
- For inside mount - Install the bracket with the hole at top center by using the included screw or with two holes at the top rear side by using #4 x 3/4" flat head wood screws (not included).
- For outside mount - install the bracket with two holes at the back side with included screws.

- Fasten the screws completely.
- Install the shade with the extension brackets (optional)
 - Install the extension bracket with at least 2 screws.
 - Attach the mounting brackets to the extension brackets with the screws.

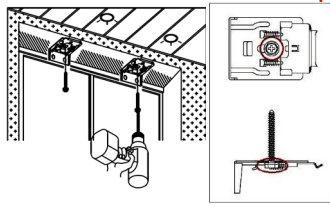

Inside Mount

Use #4 x 3/4" flat head wood screws (not included) for these two holes

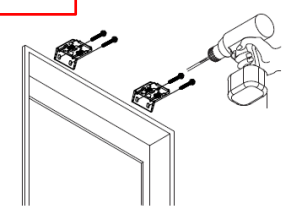

Outside Mount

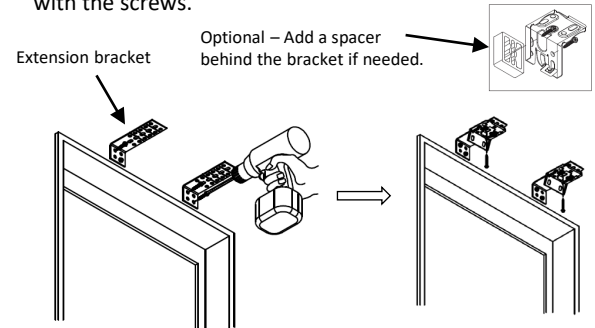

2. Install the battery power and/ or the solar panel (depending on the parts you are purchasing) - 2 sets/ per cellular shade

- Follow the installation instruction inside the Rollease Automate package to install the battery and/ or solar panel.

NOTE - THE SOLAR PANEL WORKS ONLY WITH THE RECHARGEABLE BATTERY PACK.

3. Attach the cell shade

- Position the headrail with the front lip resting on the top hooks of all the brackets.
- Push the bottom of headrail firmly upward and toward the window until the groove at the bottom of the headrail snaps into place.
- Connect the motor to the battery power.

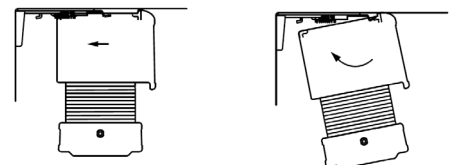

Rollease Automate Top Down Bottom Up Cellular Shades

- Installation and User Guide

4. How to remove the shade from the brackets

- Raise the shade completely. Push the headrail toward to the wall.
- Tilt the backside of the headrail down
- Once the back of the headrail clears the brackets, pull the headrail off the front of brackets.

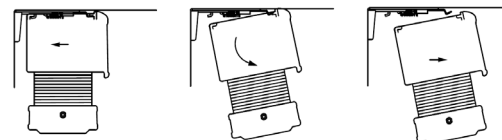

FOR 9/16" RAIL BRACKETS

1. Install the brackets

- Mark the bracket locations, separating the brackets evenly. Make sure all brackets are aligned and level with each other.
- For inside mount - Install the bracket with the holes at top by using the included screws.
- For outside mount – install the bracket with the holes at the back side with included screws.

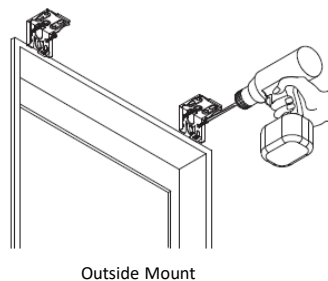
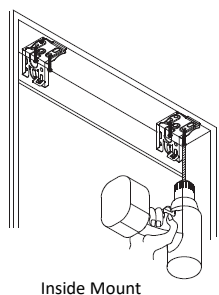

- Fasten the screws completely.
- Install the shade with the extension brackets (optional)
 - Install the extension bracket with at least 2 screws.
 - Attach the mounting brackets to the extension brackets with the screws.

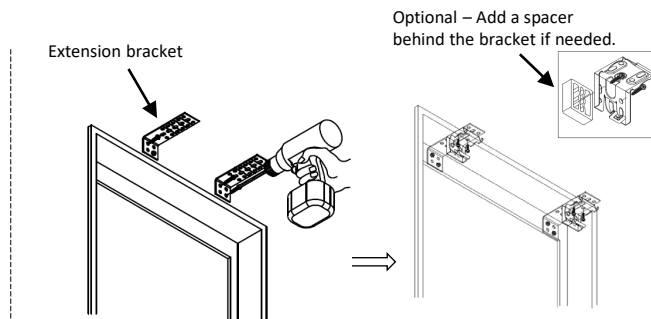

2. Install the battery power and/ or the solar panel (depending on the parts you are purchasing) - 2 sets/ per cellular shade

- Follow the installation instruction inside the Rollease Automate package to install the battery and/ or solar panel.

NOTE - THE SOLAR PANEL WORKS ONLY WITH THE RECHARGEABLE BATTERY PACK.

3. Attach the cell shade

- Position the headrail with the front lip resting on the top hooks of all the brackets.
- Push the bottom of headrail firmly upward and toward the window until the groove at the bottom of the headrail snaps into place.

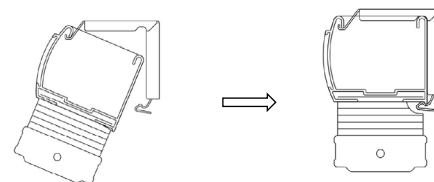

4. How to remove the shade from the brackets

- Raise the shade completely.
- Use a flat screw to push the bracket tab toward to the wall. Once you hear a “click”, then the shade will be released from the bracket.
- Repeat above step to release the shade from other brackets.

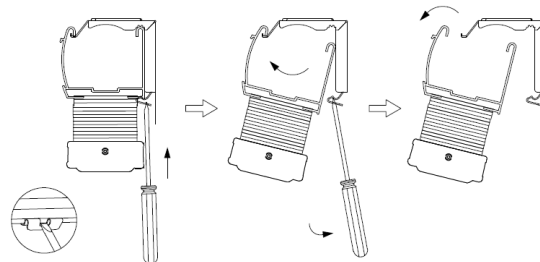

Rollease Automate Top Down Bottom Up Cellular Shades

- Installation and User Guide

Enjoy

This motorized shade is already connected to the remote and programmed with Upper and Lower Limits. Option to program "My Favorite Position", follow the instruction inside the remote box. Enjoy your new motorized shade!

Operation

- The top down bottom up default setting of the remote is CHANNEL 1 controls the middle rail; and CHANNEL 2 controls the bottom rail.
- To lower the shade, always lower the bottom rail first by pressing the channel 2, and then lower the middle rail by pressing the channel 1.
- To raise the shade, start with the middle rail by pressing channel 1, followed by the bottom rail by pressing channel 2.
- **NOTE: THE SHADE SHOULD BE OPERATED PROPERLY TO PREVENT THE CORDS FROM BECOMING LOOSE.**

Rollease motorized TDBU –

The default setting of the remote is CHANNEL 1 controls the middle rail; and CHANNEL 2 controls the bottom rail.

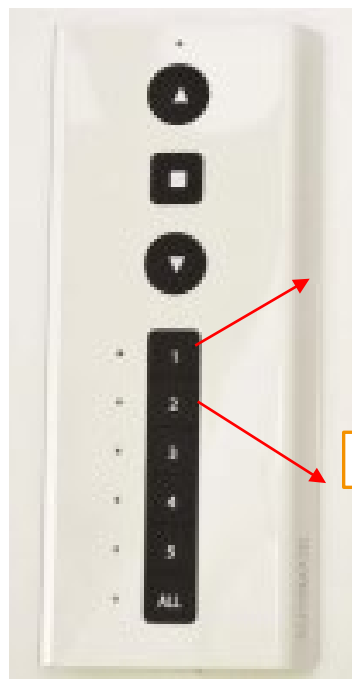

Channel 1 controls the bottom rail

Channel 2 controls the middle rail

Care and Clean

- Wipe the shade periodically with a soft dust cloth or dusting mitt, or vacuum with a lowest speed.

Notes

- Do not spill water to the headrail and the remote.
- Do not clean/ operate the motorized shade with wet hands
- The warranty for your shades does not cover damage caused by improper cleaning.
- Changing the batteries or recharging the battery pack won't change the programming setting.

