



CELLULAR SHADE

2022 PRICE GUIDE



For orders, please submit
the online orders on www.htwfonline.com,
email it to emailorder@richview.com
or fax it to **626-839-8861**

Price Guide is also available online, please visit
www.htwfonline.com.

Customer Service Department

Monday ~ Friday 6:00Am - 5:00 PM Pacific Time

Will Call Hours

Monday ~ Friday 9:00 AM - 3:30 PM Pacific Time

Phone: **626-839-8866**
Toll Free: **800-879-9512**
770 S. Epperson Dr.
City of Industry, CA 91748

CONTENTS	PAGE
General Info	
Contact Us	2
Terms of Sales	4
Freight, repair, and rush order surcharges	5
Product Info	
Custom cellular shade fabric list	6 - 7
Color/ Sizes Specification Summary	8 – 9
Pricing	10 – 14
Surcharges/ Size limitation/ Features	15
Slider	16
Cellular Shade Collection	17
Specialty	18
Motorized – Simple Touch® Wand	19
Motorized – Simple Touch® Remote	20
Motorized – Somfy shade, rechargeable battery pack, and the smart shade (myLink)	21
Simply Cordless, Top Down Bottom Up, and Day/ Night	22 – 24
Commercial Solutions	
Measure the windows	25
Warranty policy	26
Contractor quotes	27
New Account Application	28-32
Sample Order Form	33
Order Form	34

General Info

Product Info

Commercial Solutions

Price/ Quotation

All HT window fashions™ (HT) products and parts pricing are FOB City of Industry, not including freight. The price is subject to change without notice.

To ensure order accuracy, complete order options and specification information, please use the HT order form. The HT ORDER FORM can be found on the last page of the price book and on the HT website at www.htwfonline.com. Make copies to get additional blank order forms when needed.

How to submit your orders

- **Online orders**

Online ordering is available on the HT website www.htwfonline.com with your dealer login ID and password.

You will receive the order confirmation via email within 24 hours after order is submitted.

The HT online ordering system provides you with convenience, accuracy, and expediency. Please call HT customer service to obtain the dealer login ID and password.

- **Email Orders**

Dealers are able to download order form from www.htwfonline.com, then complete the order form and submit it to emailorder@richview.com.

- **Fax Orders**

Faxed orders will be confirmed within 24 hours. Fax number is 626-839-8861.

Cancellation or Change Order

IMPORTANT! Due to the customized nature of our products, we can not accept changes or cancellations after orders have been put into production.

Order Tracking and Status

Order confirmations are sent via email within 24 hours of placing order. Please make sure you have your email on file with HT.

Faxed confirmations are available upon request only. To track your order or check the status of your order, please contact customer service with your work order number.

Lead Time

Typically, custom orders (less than 15 units) are manufactured and shipped within 5 business days. All custom and stock orders are subject to inventory availability. Orders placed after 2:30 p.m. PST are considered as next day business.

Contractor Quote/Commercial Quote

HT window fashions™ (HT) is an industry leader in providing medium and large contract/commercial quotes.

Contract/Commercial Quotation Requirements

- Minimum quantity for cellular shade and others: 15
- All stock shade quotes are valid for 3 days only.
- All custom shade quotes are valid for 90 days only.
- Expired quotes are subject to a 0.5% increase per month.

Quote policy

- HT does not guarantee stock shade availability in all sizes. Order quantities are subject to final confirmation.
- Shipping date will be confirmed upon placement of order and is dependent on stock availability, total units, production and scheduling considerations.
- Quoted price does not include tax.
- Any change, including but not limited to size, color, controls, quantity, ship to location, ship date or number of the shipments, may result in a change in price.
- Deposit may be required.



Freight

STANDARD SHIPPING & HANDLING, DELIVERY & FREIGHT POLICIES:

- \$6.00 freight charge per unit for the cellular shade.
- The minimum freight charge is \$15.00 per order.
- Oversize (94" or above) charge is \$85.00 per shipment without quality limit. Oversize charge is in addition to the freight charge.
- For the express shipment, shipment to Alaska, Hawaii and foreign countries, freight will be quoted separately.
- Freight collect and using preferred carrier is optional.
- Next Day, 2nd Day Air and 3 Day select shipping options are available. Actual freight will be applied.

FREIGHT DAMAGE AND SHORTAGES:

Please inspect all shipments immediately and carefully. Please report the damages and shortages on the delivery receipt and notify HT customer service within 48 hours. No freight damage claim will be accepted after 30 days from shipping.

Repair Fees

REPAIRING SERVICES	FEES/ PER SHADE
Shorten height	\$16.00
Cut down width	\$16.00
Restrung	\$21.00
Change control position	\$21.00
Replace headrail or bottomrail	\$21.00

CELLULAR OPTION CHANGES	FEES/ PER SHADE
If new shade costs more than original shade	\$37.00 plus cost difference per shade
If new shade costs less than original shade	\$37.00 standard per shade

MINIMUM REPAIR CHARGE	\$20.00
-----------------------	---------

****NOTE:** All repair charges do not include freight. Standard shipping charges will be applied.

RUSH ORDER SURCHARGES

- Rush orders are subject to inventory availability and production schedule.
- Same day rush must be submitted by 10 a.m. PST/PDT to be processed that business day.
- 24- and 48- hour rushes must be submitted by 2:30 p.m. PST/PDT to be processed that business day

RUSH OPTIONS	SURCHARGE/ PER SHADE
Same day production rush	\$40.00
24-hour rush	\$15.00
48-hour rush	\$8.00

The HT window fashions cellular shade collection is one of the most fashionable and comprehensive in the industry. We offer a variety of single cell and double cell cellular shade fabrics, from light filtering to blackout, in neutral tonal shades to rich pigment tones. The specialty fabrics such as sheers, slub wovens, prints, crushes, and Cell-in-a-Cell give you more choices and creativity. There are also fire retardant fabrics available for commercial applications.

3/4" FABRIC ITEM LIST

3/4" Single Cell Light Filtering

PS410-001	Cotton
PS410-002	Snow White
PS410-003	Onion
PS410-004	Alabaster
PS410-005	Cream
PS410-006	Fawn
PS410-007	Biscuit
PS410-008	Pongee
PS410-009	Ocher
PS410-010	Tan
PS410-011	Terra Cotta
PS410-012	Cocoa
PS410-013	Spring Green
PS410-014	Water Green
PS410-015	Avocado
PS410-016	Roseate
PS410-019	Agate Red
PS410-020	Bordeaux
PS410-021	Gray Sheen
PS410-022	Marine Blue
PS410-023	Royal Gray
PS410-024	Jean Blue
PS410-025	Black
PS410-026	Wisteria
PS410-030	Anthracite
PS410-069	White Dove
PS410-070	Winter White
PS410-346	Antique Pewter
PS410-470	Slate
PS410-326	Dark Chocolate

3/4" Single Cell Smooth Light Filtering

PS43C-001	Cotton
PS43C-002	Snow White
PS43C-005	Cream
PS43C-070	Winter White

3/4" Single Cell Bamboo Print

PS41RA-023	Royal Gray
PS41RA-346	Antique Pewter
PS41RA-514	Misty Gray
PS41RA-519	Stone
PS41RA-583	Dark Gray Sheen

3/4" Single Cell LUX Linen

PS47B-901	Porcelain
PS47B-919	Camel
PS47B-921	Stonington Gray
PS47B-930	Charcoal
PS47B-992	Hazelnut

3/4" Cell-In-A Cell

PU41SS-001	Cotton
PU41SS-763	Taupe
PU41SS-764	Beige
PU41SS-765	Ivory
PU41SS-766	Classic Gray

3/4" Single Cell Blackout

PS420-001	Cotton
PS420-002	Snow White
PS420-003	Onion
PS420-004	Alabaster
PS420-006	Fawn
PS420-008	Pongee
PS420-009	Ocher
PS420-012	Cocoa
PS420-015	Avocado
PS420-020	Bordeaux
PS420-021	Gray Sheen
PS420-024	Jean Blue
PS420-025	Black
PS420-069	White Dove
PS420-070	Winter White
PS420-326	Dark Chocolate
PS420-346	Antique Pewter
PS420-470	Slate

3/4" Single Cell Smooth Blackout

PS44C-002	Snow White
PS44C-005	Cream
PS44C-021	Gray Sheen
PS44C-070	Winter White

3/4" Single Cell Bamboo Print Blackout

PS42RA-023	Royal Gray
PS42RA-346	Antique Pewter
PS42RA-514	Misty Gray
PS42RA-519	Stone
PS42RA-583	Dark Gray Sheen

Fabric Selections

9/16" & 7/16" FABRIC ITEM LIST

Fabric Selections

9/16" Single Cell Light Filtering

PS310-001	Cotton
PS310-002	Snow White
PS310-003	Onion
PS310-004	Alabaster
PS310-005	Cream
PS310-006	Fawn
PS310-007	Biscuit
PS310-008	Pongee
PS310-009	Ocher
PS310-010	Tan
PS310-011	Terra Cotta
PS310-012	Cocoa
PS310-013	Spring Green
PS310-014	Water Green
PS310-015	Avocado
PS310-016	Roseate
PS310-019	Agate Red
PS310-020	Bordeaux
PS310-021	Gray Sheen
PS310-022	Marine Blue
PS310-023	Royal Gray
PS310-024	Jean Blue
PS310-025	Black
PS310-026	Wisteria
PS310-030	Anthracite
PS310-069	White Dove
PS310-070	Winter White
PS310-346	Antique Pewter
PS310-470	Slate
PS310-326	Dark Chocolate

9/16" Single Cell Linen Print

PS331-012	Cocoa
PS331-032	Sand
PS331-034	Gray
PS331-326	Dark Chocolate
PS331-514	Misty Gray

9/16" Single Cell Fire Retardant Light Filtering

PS310-001FR	Cotton
PS310-006FR	Fawn
PS310-008FR	Pongee
PS310-070FR	Winter White

9/16" Single Cell Sheer

PS360-001	Cotton
PS360-002	Snow White
PS360-004	Alabaster
PS360-006	Fawn
PS360-012	Cocoa

9/16" Single Cell Crush

PS310-001CR	Cotton
PS310-069CR	White Dove
PS310-070CR	Winter White
PS310-006CR	Fawn
PS310-012CR	Cocoa

9/16" Single Cell Slub Woven

PS375-001	Cotton
PS375-004	Alabaster
PS375-012	Cocoa
PS375-021	Gray Sheen
PS375-326	Dark Chocolate

9/16" Single Cell Blackout

PS320-001	Cotton
PS320-002	Snow White
PS320-003	Onion
PS320-004	Alabaster
PS320-006	Fawn
PS320-008	Pongee
PS320-009	Ocher
PS320-012	Cocoa
PS320-015	Avocado
PS320-020	Bordeaux
PS320-021	Gray Sheen
PS320-024	Jean Blue
PS320-025	Black
PS320-069	White Dove
PS320-070	Winter White
PS320-326	Dark Chocolate
PS320-346	Antique Pewter
PS320-470	Slate

9/16" Single Cell Fire Retardant Blackout

PS320-001FR	Cotton
PS320-006FR	Fawn
PS320-008FR	Pongee
PS320-070FR	Winter White

7/16" Double Cell Light Filtering

PX3A0-001	Cotton
PX3A0-069	White Dove
PX3A0-070	Winter White
PX3A0-002	Snow White
PX3A0-003	Onion
PX3A0-004	Alabaster
PX3A0-005	Cream
PX3A0-006	Fawn
PX3A0-007	Biscuit
PX3A0-008	Pongee
PX3A0-009	Ocher
PX3A0-010	Tan
PX3A0-011	Terra Cotta
PX3A0-012	Cocoa
PX3A0-014	Water Green
PX3A0-015	Avocado
PX3A0-016	Roseate
PX3A0-019	Agate Red
PX3A0-020	Bordeaux
PX3A0-021	Gray Sheen
PX3A0-022	Marine Blue
PX3A0-023	Royal Gray
PX3A0-024	Jean Blue
PX3A0-025	Black
PX3A0-326	Dark Chocolate

Fabric Color No.	Fabric Color Name	9/16"	9/16"	9/16"	9/16"	9/16"	9/16"	9/16"	3/4"	3/4"	3/4"	3/4"	3/4"	3/4"	3/4"	7/16"	Rails, cord, end cap, clutch, tassel, and stop balls
		Single Cell Light Filtering	Single Cell Blackout	Single cell Linen Print	Single Cell Sheer	Single Cell Crush	Single Cell Slub Woven	Single Cell Fire Retardant	Single Cell Light Filtering	Single Cell Blackout	Single Cell Bamboo	Single Cell Smooth Light Filtering	Single Cell Smooth Blackout	Single Cell LUX Linen	Cell-In-A Cell Light Filtering	Double Cell Light Filtering	
001	Cotton	✓	✓	N/A	✓	✓	✓	✓	✓	✓	N/A	✓	N/A	N/A	✓	✓	001
002	Snow White	✓	✓	N/A	✓	N/A	N/A	N/A	✓	✓	N/A	✓	✓	N/A	N/A	✓	002
003	Onion	✓	✓	N/A	N/A	N/A	N/A	N/A	✓	✓	N/A	N/A	N/A	N/A	N/A	✓	006
004	Alabaster	✓	✓	N/A	✓	N/A	✓	N/A	✓	✓	N/A	N/A	N/A	N/A	N/A	✓	
005	Cream	✓	N/A	N/A	N/A	N/A	N/A	N/A	✓	N/A	N/A	✓	✓	N/A	N/A	✓	
006	Fawn	✓	✓	N/A	✓	✓	N/A	✓	✓	✓	N/A	N/A	N/A	N/A	N/A	✓	
007	Biscuit	✓	N/A	N/A	N/A	N/A	N/A	N/A	✓	N/A	N/A	N/A	N/A	N/A	N/A	✓	
008	Pongee	✓	✓	N/A	N/A	N/A	N/A	✓	✓	✓	N/A	N/A	N/A	N/A	N/A	✓	008
009	Ocher	✓	✓	N/A	N/A	N/A	N/A	N/A	✓	✓	N/A	N/A	N/A	N/A	N/A	✓	010
010	Tan	✓	N/A	N/A	N/A	N/A	N/A	N/A	✓	N/A	N/A	N/A	N/A	N/A	N/A	✓	
011	Terra Cotta	✓	N/A	N/A	N/A	N/A	N/A	N/A	✓	N/A	N/A	N/A	N/A	N/A	N/A	✓	
012	Cocoa	✓	✓	✓	✓	✓	✓	N/A	✓	✓	N/A	✓	N/A	N/A	N/A	✓	012
013	Spring Green	✓	N/A	N/A	N/A	N/A	N/A	N/A	✓	N/A	N/A	N/A	N/A	N/A	N/A	N/A	002
014	Water Green	✓	N/A	N/A	N/A	N/A	N/A	N/A	✓	N/A	N/A	N/A	N/A	N/A	N/A	✓	014
015	Avocado	✓	✓	N/A	N/A	N/A	N/A	N/A	✓	✓	N/A	N/A	N/A	N/A	N/A	✓	015
016	Roseate	✓	N/A	N/A	N/A	N/A	N/A	N/A	✓	N/A	N/A	N/A	N/A	N/A	N/A	✓	016
019	Agate Red	✓	N/A	N/A	N/A	N/A	N/A	N/A	✓	N/A	N/A	N/A	N/A	N/A	N/A	✓	019
020	Bordeaux	✓	✓	N/A	N/A	N/A	N/A	N/A	✓	✓	N/A	N/A	N/A	N/A	N/A	✓	020
021	Gray Sheen	✓	✓	N/A	N/A	N/A	✓	N/A	✓	✓	N/A	N/A	✓	N/A	N/A	✓	091
022	Marine Blue	✓	N/A	N/A	N/A	N/A	N/A	N/A	✓	N/A	N/A	N/A	N/A	N/A	N/A	✓	028
023	Royal Gray (Bamboo)	N/A	N/A	N/A	N/A	N/A	N/A	N/A	N/A	N/A	✓	N/A	N/A	N/A	N/A	N/A	091
023	Royal Gray	✓	N/A	N/A	N/A	N/A	N/A	N/A	✓	N/A	N/A	N/A	N/A	N/A	N/A	✓	023
024	Jean Blue	✓	✓	N/A	N/A	N/A	N/A	N/A	✓	✓	N/A	N/A	N/A	N/A	N/A	✓	
025	Black	✓	✓	N/A	N/A	N/A	N/A	N/A	✓	✓	N/A	N/A	N/A	N/A	N/A	✓	025
026	Wisteria	✓	N/A	N/A	N/A	N/A	N/A	N/A	✓	N/A	N/A	N/A	N/A	N/A	N/A	N/A	026
030	Anthracite	✓	N/A	N/A	N/A	N/A	N/A	N/A	✓	N/A	N/A	N/A	N/A	N/A	N/A	N/A	025
032	Sand	N/A	N/A	✓	N/A	N/A	N/A	N/A	N/A	N/A	N/A	N/A	N/A	N/A	N/A	N/A	006
034	Gray	N/A	N/A	✓	N/A	N/A	N/A	N/A	N/A	N/A	N/A	N/A	N/A	N/A	N/A	N/A	091
069	White Dove	✓	✓	N/A	N/A	✓	N/A	N/A	✓	✓	N/A	N/A	N/A	N/A	N/A	✓	001
070	Winter White	✓	✓	N/A	N/A	✓	N/A	✓	✓	✓	N/A	✓	✓	N/A	N/A	✓	002
326	Dark Chocolate	✓	✓	✓	N/A	N/A	✓	N/A	✓	✓	N/A	N/A	N/A	N/A	N/A	✓	326
344	Pebble	N/A	N/A	N/A	N/A	N/A	N/A	N/A	N/A	N/A	N/A	N/A	N/A	N/A	N/A	N/A	091
346	Antique Pewter (Bamboo)	N/A	N/A	N/A	N/A	N/A	N/A	N/A	N/A	N/A	✓	N/A	N/A	N/A	N/A	N/A	002
346	Antique Pewter	✓	✓	N/A	N/A	N/A	N/A	N/A	✓	✓	N/A	N/A	N/A	N/A	N/A	N/A	025
470	Slate	✓	✓	N/A	N/A	N/A	N/A	N/A	✓	✓	N/A	N/A	N/A	N/A	N/A	N/A	
514	Misty Gray	N/A	N/A	✓	N/A	N/A	N/A	N/A	N/A	N/A	✓	N/A	N/A	N/A	N/A	N/A	
519	Stone	N/A	N/A	N/A	N/A	N/A	N/A	N/A	N/A	N/A	✓	N/A	N/A	N/A	N/A	N/A	006
583	Dark Grey Sheen	N/A	N/A	N/A	N/A	N/A	N/A	N/A	N/A	N/A	✓	N/A	N/A	N/A	N/A	N/A	091
763	Taupe	N/A	N/A	N/A	N/A	N/A	N/A	N/A	N/A	N/A	N/A	N/A	N/A	N/A	✓	N/A	002
764	Beige	N/A	N/A	N/A	N/A	N/A	N/A	N/A	N/A	N/A	N/A	N/A	N/A	N/A	✓	N/A	
765	Ivory	N/A	N/A	N/A	N/A	N/A	N/A	N/A	N/A	N/A	N/A	N/A	N/A	N/A	✓	N/A	
766	Classic Gray	N/A	N/A	N/A	N/A	N/A	N/A	N/A	N/A	N/A	N/A	N/A	N/A	N/A	✓	N/A	091
901	Porcelain	N/A	N/A	N/A	N/A	N/A	N/A	N/A	N/A	N/A	N/A	N/A	N/A	✓	N/A	N/A	001
919	Camel	N/A	N/A	N/A	N/A	N/A	N/A	N/A	N/A	N/A	N/A	N/A	N/A	✓	N/A	N/A	006
921	Stonington Gray	N/A	N/A	N/A	N/A	N/A	N/A	N/A	N/A	N/A	N/A	N/A	N/A	✓	N/A	N/A	091
930	Charcoal	N/A	N/A	N/A	N/A	N/A	N/A	N/A	N/A	N/A	N/A	N/A	N/A	✓	N/A	N/A	
992	Hazelnut	N/A	N/A	N/A	N/A	N/A	N/A	N/A	N/A	N/A	N/A	N/A	N/A	✓	N/A	N/A	012

*Product specification is subject to change without notice.

Specification

Stacking Chart: This includes headrail and bottomrail (for corded system)											R Value
Fabric Type	36" Drop	48" Drop	60" Drop	72" Drop	84" Drop	96" Drop	108" Drop	120" Drop	132" Drop	144" Drop	
9/16" Single Light Filtering	2.00	2.25	2.50	2.80	3.00	3.30	3.50	3.83	4.00	4.33	3.5
9/16" Single Cell Blackout	1.81	2.00	2.19	2.38	2.56	2.75	2.94	3.13	3.31	3.50	4.3
9/16" Single Cell Linen Print LF	2.13	2.38	2.63	2.88	3.13	3.38	3.63	3.88	4.13	4.38	3.5
9/16" Single Cell Sheer	2.29	2.62	2.88	3.15	3.42	3.69	3.96	4.22	4.49	4.76	0.7
9/16" Single Cell Crush	2.47	2.84	3.16	3.47	3.78	4.09	4.41	4.72	5.03	5.34	3.4
9/16" Single Cell Slub Woven	2.25	2.54	2.83	3.13	3.42	3.71	4.00	4.29	4.58	4.88	2.8
3/4" Single Light Filtering	1.83	1.98	2.13	2.28	2.43	2.58	2.73	2.88	3.03	3.18	3.8
3/4" Single Cell Blackout	1.88	2.01	2.14	2.30	2.44	2.57	2.73	2.85	3.00	3.13	4.4
3/4" Single Bamboo Light Filtering	1.88	2.01	2.14	2.30	2.44	2.58	2.75	2.88	3.03	3.18	3.8
3/4" Single Bamboo Blackout	1.83	1.98	2.13	2.28	2.43	2.57	2.73	2.85	3.00	3.13	4.4
3/4" Single Smooth Light Filtering	1.75	1.88	2.00	2.13	2.25	2.38	2.50	2.63	2.75	2.88	3.7
3/4" Single Smooth Blackout	1.52	1.60	1.68	1.76	1.84	1.92	2.01	2.09	2.18	2.26	4.4
3/4" Single Cell LUX Linen	1.93	2.15	2.38	2.60	2.83	3.05	3.28	3.50	3.73	3.95	2.8
3/4" Cell-In-A Cell Light Filtering	2.71	3.14	3.57	4.00	4.43	5.00	N/A	N/A	N/A	N/A	5.5
7/16" Double Cell Light Filtering	2.43	2.82	3.21	3.61	4.00	4.39	4.79	5.18	5.57	5.96	3.6

Note: For Cordless and Clutch systems, add 7/8" to above chart stack. All stacking sizes are approximate.

Minimum Mounting Space										
Cell Size	Mount Space Type	Corded	Corded TDBU	Clutch	Clutch TDBU	Cordless	Cordless Plus	Cordless TDBU	Simple Touch®	Somfy
9/16" & 7/16"	Minimum mounting Space	1/2"	1/2"	7/8"	7/8"	7/8"	7/8"	7/8"	7/8"	7/8"
	Minimum flush inside mounting space	1-7/8"	1-7/8"	2"	2"	2"	2"	2"	2"	2"
3/4"	Minimum mounting Space	1/2"	1/2"	7/8"	7/8"	7/8"	7/8"	7/8"	7/8"	7/8"
	Minimum flush inside mounting space	2-3/8"	2-3/8"	2-1/8"	2-1/8"	2-1/8"	2-1/8"	2-1/8"	2-1/8"	2-1/8"

Note. The minimum mount space 1/2" of the corded cellular shade requires the flat head screws that are not included in the hardware.

Standard Cord Control			
Width	Cord Route	Lift Cord #	Cord Lock
5" ~ 12.9"	2.5"	2	3/4"
13" ~ 24.9"	4"	2	2"
25" ~ 36.9"	8"	2	2"
37" ~ 64.9"	12"	2	2"
65" ~ 104.9"	12"	3	2"
≥ 105"	12"	4	2"

Headrail Bracket Quantities for Each Operation System				
Width	Regular Corded	Cordless and Clutch	Top Down Bottom Up	Day/Night
5 ~ 47.9"	2	2	2	2
48" ~ 72.9"	3	3	4	4
73" ~ 83.9"	4	4	N/A	N/A
84" ~ 95.9"	4	4 (Clutch only)	N/A	N/A
96" ~ 120.9"	5	5 (Clutch only)	N/A	N/A
121" ~ 144"	6 (not apply to the Cell-In-A Cell)	6 (Clutch only)	N/A	N/A

Continuous Cord Length	
Shade Height	Cord Length
40" - 57.9"	3 feet
58" - 72.9"	4 feet
73" - 85.9"	5 feet
86" - 107.9"	6 feet
≥ 108"	8 feet

*Product specification is subject to change without notice.

Price Group Chart	
Price Group Chart/ By Fabric Types	Price Group
9/16"	9/16" Single Cell Linen Print 1
	9/16" Single Cell Light Filtering 2
	9/16" Single Cell Fire Retardant Light Filtering 5
	9/16" Single Cell Blackout 6
	9/16" Single Cell Sheer 8
	9/16" Single Cell Fire Retardant Blackout 9
	9/16" Single Cell Crush 9
	9/16" Single Cell Slub Woven 9
3/4"	3/4" Single Cell Smooth Light Filtering 1
	3/4" Single Cell Light Filtering 3
	3/4" Single Cell Bamboo Light Filtering 3
	3/4" Single Cell Smooth Blackout 5
	3/4" Single Cell Bamboo Blackout 7
	3/4" Single Cell Blackout 7
	3/4" Single Cell LUX Linen 9
	3/4" Cell-In-A Cell Light Filtering 9
7/16"	7/16" Double Cell Light Filtering 4

9/16" – Single Cell Light Filtering Linen Print														GROUP 1		
3/4" – Single Cell Light Filtering Smooth (see 3/4" Smooth Blackout prices on Group 5)																
WIDTH TO:	7" - 24"	30"	36"	42"	48"	54"	60"	66"	72"	84"	96"	108"	120"	132"	144"	
HEIGHT TO:	5" - 36"	235	270	309	350	385	432	472	512	555	642	727	810	897	982	1064
	42"	253	293	337	384	424	474	522	569	614	711	807	899	995	1091	1183
	48"	269	315	361	413	456	515	563	617	670	774	878	982	1090	1195	1297
	54"	294	344	398	451	502	563	618	680	736	850	965	1079	1197	1311	1425
	60"	317	370	432	488	540	610	670	735	795	919	1045	1170	1293	1418	1543
	66"	341	399	462	523	585	656	720	790	856	990	1127	1257	1398	1529	1664
	72"	362	424	493	561	625	701	773	846	917	1059	1209	1349	1496	1638	1784
	78"	381	450	520	591	670	744	824	900	979	1131	1287	1437	1594	1749	1902
	84"	397	471	549	624	703	782	866	948	1026	1187	1353	1514	1685	1846	2011
	90"	415	495	576	657	739	828	911	999	1089	1258	1430	1604	1779	1951	2124
	96"	433	516	601	687	774	866	956	1048	1137	1318	1502	1681	1867	2046	2229
	108"	472	561	656	750	848	949	1049	1147	1249	1447	1649	1845	2051	2248	2448
	120"	505	608	713	818	926	1035	1141	1253	1359	1574	1796	2012	2233	2450	2668
	132"	538	652	763	879	998	1115	1234	1351	1468	1706	1944	2175	2418	2647	2883
144"	575	696	820	945	1071	1198	1325	1451	1577	1833	2087	2341	2601	2848	3104	

Manufacturer's suggested retail price

Notes

- 2-on-1 and 3-on-1 headrail option is strongly recommended for the shades measuring 96" or more in width or height.

9/16" – Single Cell Light Filtering (see 9/16" Blackout prices on Group 6)													GROUP		2	
WIDTH TO:	7" - 24"	30"	36"	42"	48"	54"	60"	66"	72"	84"	96"	108"	120"	132"	144"	
HEIGHT TO:	5" - 36"	266	306	350	397	438	491	536	581	631	730	826	919	1019	1116	1208
	42"	287	333	382	437	482	539	594	645	697	809	916	1021	1131	1240	1344
	48"	305	358	411	469	519	585	640	701	760	879	998	1116	1239	1358	1474
	54"	334	392	452	513	571	639	702	774	835	966	1096	1226	1362	1489	1618
	60"	361	420	490	554	615	693	760	834	903	1046	1187	1329	1469	1612	1754
	66"	388	453	524	596	665	746	817	897	972	1125	1280	1429	1589	1737	1891
	72"	412	481	559	637	711	796	878	961	1041	1205	1374	1533	1701	1862	2028
	78"	433	512	591	672	760	846	936	1024	1112	1285	1462	1634	1812	1988	2161
	84"	451	535	623	710	799	890	984	1076	1167	1348	1538	1721	1914	2098	2284
	90"	472	562	655	747	840	941	1035	1135	1237	1430	1625	1823	2021	2218	2413
	96"	493	587	683	780	879	984	1087	1190	1292	1498	1707	1910	2122	2325	2534
	108"	536	637	746	852	963	1077	1191	1305	1419	1644	1873	2095	2330	2555	2782
	120"	574	691	811	930	1051	1176	1297	1423	1545	1790	2041	2287	2539	2784	3032
	132"	612	740	868	999	1134	1267	1402	1535	1669	1938	2208	2472	2747	3008	3277
144"	654	792	932	1073	1217	1363	1505	1649	1793	2084	2371	2660	2955	3237	3526	

Manufacturer's suggested retail price

3/4" – Single Cell Light Filtering (see 3/4" Blackout prices on Group 7)													GROUP		3	
3/4" – Single Cell Light Filtering Bamboo Print (see 3/4" Bamboo Blackout prices on Group 7)																
WIDTH TO:	7" - 24"	30"	36"	42"	48"	54"	60"	66"	72"	84"	96"	108"	120"	132"	144"	
HEIGHT TO:	5" - 36"	287	331	378	429	473	530	579	628	681	788	892	993	1100	1206	1305
	42"	311	359	413	472	521	582	641	697	753	873	990	1104	1221	1339	1451
	48"	330	386	443	506	560	632	692	757	821	950	1078	1206	1338	1467	1592
	54"	360	423	488	554	616	691	758	836	901	1042	1184	1324	1470	1608	1748
	60"	390	454	529	598	664	749	821	900	976	1129	1282	1435	1587	1741	1894
	66"	418	489	567	643	719	806	882	969	1050	1214	1383	1544	1716	1876	2043
	72"	444	520	603	688	768	859	949	1038	1125	1302	1484	1655	1836	2010	2190
	78"	477	564	651	740	838	931	1031	1128	1225	1415	1610	1801	1996	2190	2380
	84"	496	590	687	782	880	980	1084	1186	1286	1485	1695	1895	2108	2310	2517
	90"	520	620	721	822	926	1037	1140	1250	1363	1575	1789	2007	2226	2442	2659
	96"	542	647	753	859	969	1084	1197	1310	1424	1651	1881	2104	2338	2562	2790
	108"	591	701	821	938	1061	1187	1311	1437	1564	1811	2063	2308	2567	2814	3064
	120"	633	760	894	1025	1158	1295	1430	1567	1702	1972	2248	2520	2797	3067	3339
	132"	674	815	956	1101	1249	1395	1544	1692	1839	2134	2432	2724	3026	3315	3610
144"	720	872	1027	1183	1340	1502	1657	1816	1975	2296	2612	2930	3255	3565	3885	

Manufacturer's suggested retail price

Notes

- 2-on-1 and 3-on-1 headrail option is strongly recommended for the shades measuring 96" or more in width or height.
- Product price only, not including freight, taxes, and other surcharges associated with the custom shade/ requests.
- Price is applied to the regular corded shade. Please check surcharges for the different operating systems.

7/16" – Double Cell Light Filtering												GROUP 4				
WIDTH TO:	7"- 24"	30"	36"	42"	48"	54"	60"	66"	72"	84"	96"	108"	120"	132"	144"	
HEIGHT TO:	5" - 36"	312	356	410	462	550	565	621	676	729	839	953	1057	1168	1274	1377
	42"	341	393	449	516	564	636	694	760	818	941	1069	1190	1316	1434	1557
	48"	355	418	481	550	607	677	747	814	887	1017	1156	1289	1426	1559	1692
	54"	388	452	520	594	663	739	813	888	961	1105	1256	1403	1556	1693	1842
	60"	424	491	571	642	720	808	885	971	1051	1214	1374	1536	1698	1830	2018
	66"	456	534	616	698	782	877	963	1052	1141	1320	1494	1669	1848	2023	2198
	72"	484	561	652	742	833	931	1021	1117	1215	1398	1593	1780	1965	2154	2333
	78"	516	610	707	807	909	1010	1111	1217	1322	1525	1732	1934	2145	2347	2549
	84"	542	644	746	855	958	1071	1178	1292	1398	1617	1835	2053	2279	2491	2708
	90"	569	676	789	901	1015	1134	1249	1369	1487	1718	1952	2182	2419	2650	2882
	96"	594	710	823	946	1068	1190	1315	1439	1561	1808	2059	2301	2551	2792	3037
	108"	648	769	899	1033	1168	1305	1435	1575	1713	1982	2247	2518	2794	3058	3332
	120"	708	843	994	1143	1292	1443	1592	1745	1894	2191	2496	2794	3098	3394	3694
	132"	763	922	1084	1248	1412	1577	1747	1909	2077	2409	2742	3071	3405	3722	4057
144"	809	982	1157	1332	1509	1690	1865	2043	2228	2582	2930	3284	3647	3995	4348	

Manufacturer's suggested retail price

3/4" – Single Cell Blackout Smooth (see 3/4" Light Filtering Smooth prices on Group 1)												GROUP 5				
9/16" – Single Cell Light Filtering Fire Retardant																
(see 9/16" Blackout Fire Retardant prices on Group 9)																
WIDTH TO:	7"- 24"	30"	36"	42"	48"	54"	60"	66"	72"	84"	96"	108"	120"	132"	144"	
HEIGHT TO:	5" - 36"	337	385	438	491	540	602	657	715	774	890	1013	1128	1248	1360	1477
	42"	367	419	479	541	600	671	729	794	860	995	1128	1257	1395	1523	1729
	48"	396	459	529	600	663	742	812	892	963	1116	1270	1417	1574	1722	1870
	54"	434	500	575	657	730	813	894	979	1057	1226	1395	1558	1729	1891	2058
	60"	477	536	621	710	788	880	962	1060	1150	1331	1514	1690	1876	2059	2236
	66"	504	574	665	758	848	947	1038	1139	1236	1431	1631	1828	2025	2213	2413
	72"	539	620	722	823	920	1029	1129	1241	1344	1559	1780	1993	2209	2421	2636
	78"	573	656	764	873	982	1094	1205	1324	1432	1662	1894	2123	2358	2581	2813
	84"	598	690	808	926	1034	1158	1272	1400	1516	1765	2008	2249	2501	2745	2989
	90"	632	736	860	982	1105	1236	1359	1495	1623	1887	2147	2412	2680	2943	3211
	96"	655	769	899	1032	1159	1297	1429	1571	1709	1983	2265	2542	2826	3106	3386
	108"	711	836	985	1133	1278	1430	1573	1732	1883	2188	2499	2805	3120	3430	3741
	120"	764	910	1071	1231	1429	1557	1720	1892	2057	2391	2727	3072	3414	3755	4187
	132"	829	987	1168	1347	1564	1706	1886	2070	2253	2621	2995	3364	3747	4238	4829
144"	883	1059	1249	1444	1696	1840	2033	2227	2427	2824	3226	3629	4114	4703	5372	

Manufacturer's suggested retail price

Notes

- 2-on-1 and 3-on-1 headrail option is strongly recommended for the shades measuring 96" or more in width or height.
- Product price only, not including freight, taxes, and other surcharges associated with the custom shade/ requests.
- Price is applied to the regular corded shade. Please check surcharges for the different operating systems.

9/16" – Single Cell Blackout (see 9/16" Light Filtering prices on Group 2)												GROUP				6
WIDTH TO:	7" - 24"	30"	36"	42"	48"	54"	60"	66"	72"	84"	96"	108"	120"	132"	144"	
HEIGHT TO:	5" - 36"	365	419	477	534	588	655	714	777	841	967	1100	1226	1357	1478	1605
	42"	400	455	520	589	653	729	792	863	935	1081	1227	1367	1516	1655	1880
	48"	431	499	574	653	722	808	882	969	1048	1212	1379	1541	1711	1870	2033
	54"	472	544	625	714	794	883	971	1065	1150	1332	1516	1694	1880	2055	2238
	60"	518	583	675	772	856	956	1047	1153	1249	1447	1645	1836	2039	2239	2429
	66"	549	623	723	824	921	1029	1128	1238	1344	1555	1772	1987	2202	2406	2623
	72"	587	674	786	895	1000	1118	1228	1349	1461	1695	1934	2166	2401	2633	2864
	78"	622	713	831	949	1068	1190	1309	1438	1556	1807	2059	2308	2563	2805	3057
	84"	650	749	878	1006	1124	1259	1383	1523	1649	1919	2184	2445	2719	2984	3250
	90"	687	799	935	1068	1201	1344	1477	1625	1764	2051	2335	2622	2914	3198	3490
	96"	712	835	978	1121	1260	1411	1553	1708	1857	2155	2463	2763	3072	3377	3681
	108"	773	910	1070	1231	1390	1554	1710	1883	2047	2379	2716	3049	3392	3728	4067
	120"	831	989	1164	1338	1553	1693	1868	2057	2236	2599	2965	3339	3711	4081	4551
	132"	900	1073	1269	1464	1698	1853	2050	2250	2449	2848	3255	3657	4073	4607	5248
144"	960	1152	1358	1569	1845	2000	2210	2421	2638	3069	3506	3945	4472	5111	5841	

Manufacturer's suggested retail price

3/4" – Single Cell Blackout (see 3/4" Light Filtering prices on Group 3)												GROUP				7
3/4" – Single Cell Blackout Bamboo Print (see 3/4" Light Filtering Bamboo Print prices on Group 3)																
WIDTH TO:	7" - 24"	30"	36"	42"	48"	54"	60"	66"	72"	84"	96"	108"	120"	132"	144"	
HEIGHT TO:	5" - 36"	402	461	524	588	647	720	786	855	926	1064	1211	1348	1493	1626	1765
	42"	440	500	572	648	718	801	871	950	1029	1190	1350	1504	1668	1821	2068
	48"	474	549	632	718	795	889	971	1066	1153	1333	1517	1694	1883	2058	2237
	54"	519	599	688	786	873	972	1068	1171	1265	1466	1668	1864	2068	2261	2462
	60"	570	641	742	849	941	1052	1151	1269	1374	1591	1809	2020	2243	2463	2673
	66"	603	686	796	907	1014	1132	1240	1363	1478	1711	1949	2186	2422	2647	2885
	72"	645	741	865	985	1100	1230	1351	1484	1607	1865	2128	2383	2641	2896	3151
	78"	684	784	914	1044	1174	1309	1439	1583	1712	1988	2265	2539	2819	3085	3362
	84"	715	823	966	1107	1236	1386	1521	1675	1814	2110	2402	2689	2991	3282	3575
	90"	755	879	1029	1174	1322	1478	1625	1787	1941	2257	2568	2884	3205	3518	3838
	96"	783	918	1076	1234	1387	1552	1709	1879	2043	2371	2709	3039	3379	3715	4050
	108"	850	1000	1177	1354	1529	1710	1881	2071	2251	2617	2987	3355	3731	4100	4473
	120"	914	1088	1280	1472	1709	1863	2054	2262	2459	2859	3262	3673	4081	4490	5006
	132"	991	1180	1396	1610	1868	2039	2256	2476	2695	3134	3580	4022	4481	5068	5773
144"	1056	1267	1494	1726	2029	2200	2431	2663	2902	3377	3857	4339	4920	5622	6425	

Manufacturer's suggested retail price

Notes

- 2-on-1 and 3-on-1 headrail option is strongly recommended for the shades measuring 96" or more in width or height.
- Product price only, not including freight, taxes, and other surcharges associated with the custom shade/ requests.
- Price is applied to the regular corded shade. Please check surcharges for the different operating systems.

9/16" – Single Cell Light Filtering Sheer													GROUP		8	
WIDTH TO:	7" - 24"	30"	36"	42"	48"	54"	60"	66"	72"	84"	96"	108"	120"	132"	144"	
5" - 36"	446	513	585	665	735	822	897	972	1055	1223	1382	1539	1707	1868	2022	
42"	481	557	640	732	808	902	995	1081	1168	1353	1534	1710	1892	2075	2248	
48"	511	599	688	786	869	980	1072	1173	1273	1471	1671	1868	2074	2273	2468	
54"	559	655	757	858	955	1070	1175	1295	1398	1616	1833	2052	2279	2492	2709	
60"	604	704	821	928	1029	1160	1273	1396	1513	1749	1986	2225	2460	2699	2936	
66"	650	758	878	997	1114	1248	1368	1502	1627	1883	2144	2392	2660	2908	3164	
72"	689	806	936	1067	1190	1333	1470	1609	1744	2016	2300	2566	2846	3117	3395	
78"	724	856	989	1125	1273	1415	1568	1713	1863	2151	2446	2736	3034	3329	3618	
84"	755	895	1045	1189	1339	1488	1646	1802	1952	2257	2576	2880	3205	3510	3824	
90"	791	941	1097	1250	1407	1574	1732	1900	2070	2393	2721	3051	3383	3711	4039	
96"	824	982	1143	1307	1471	1646	1819	1991	2162	2507	2858	3197	3552	3892	4241	
108"	897	1067	1248	1427	1612	1805	1994	2184	2377	2753	3136	3509	3901	4276	4657	
120"	961	1156	1357	1556	1760	1969	2172	2382	2585	2997	3417	3828	4250	4662	5074	
132"	1025	1239	1453	1673	1898	2122	2347	2570	2794	3244	3696	4139	4600	5075	5575	
144"	1094	1326	1559	1796	2037	2281	2520	2760	3002	3488	3971	4453	4942	5418	5918	

Manufacturer's suggested retail price

3/4" – Single Cell Light Filtering LUX Linen													GROUP		9	
3/4" – Cell-In-A Cell Light Filtering																
9/16" – Single Cell Light Filtering Crush																
9/16" – Single Cell Light Filtering Slub Woven																
9/16" – Single Cell Blackout Fire Retardant (see 9/16" Light Filtering Fire Retardant prices on Group 5)																
WIDTH TO:	7" - 24"	30"	36"	42"	48"	54"	60"	66"	72"	84"	96"	108"	120"	132"	144"	
5" - 36"	490	562	642	730	807	901	985	1067	1158	1342	1516	1690	1873	2050	2219	
42"	529	611	703	804	886	990	1091	1187	1280	1485	1684	1876	2075	2278	2467	
48"	559	657	755	861	953	1075	1176	1288	1396	1615	1833	2050	2277	2495	2708	
54"	615	719	831	941	1049	1174	1290	1420	1534	1773	2012	2252	2501	2736	2973	
60"	662	773	900	1017	1128	1274	1396	1532	1660	1920	2179	2442	2698	2962	3222	
66"	712	832	963	1093	1223	1369	1502	1647	1785	2066	2352	2625	2919	3191	3473	
72"	756	883	1028	1171	1306	1464	1614	1766	1913	2212	2524	2816	3123	3419	3726	
78"	795	938	1086	1235	1396	1553	1721	1881	2044	2361	2684	3001	3329	3653	3970	
84"	828	982	1146	1305	1469	1633	1807	1978	2142	2477	2826	3160	3517	3852	4196	
90"	868	1033	1204	1371	1543	1728	1901	2085	2272	2626	2985	3347	3713	4072	4432	
96"	905	1077	1254	1433	1615	1807	1996	2186	2373	2753	3136	3508	3897	4271	4654	
108"	985	1171	1369	1566	1770	1981	2188	2396	2607	3020	3440	3850	4281	4692	5110	
120"	1054	1269	1489	1708	1931	2161	2383	2615	2836	3289	3749	4199	4664	5114	5568	
132"	1125	1360	1594	1835	2083	2328	2576	2820	3065	3559	4056	4542	5047	5526	6019	
144"	1201	1454	1711	1971	2236	2503	2765	3028	3294	3828	4358	4886	5428	5945	6479	

Manufacturer's suggested retail price

Notes

- 2-on-1 and 3-on-1 headrail option is strongly recommended for the shades measuring 96" or more in width or height.
- Product price only, not including freight, taxes, and other surcharges associated with the custom shade/ requests.
- Price is applied to the regular corded shade. Please check surcharges for the different operating systems.

Surcharges	Add to the regular corded shade prices													
WIDTH TO:	24"	30"	36"	42"	48"	54"	60"	66"	72"	84"	96"	108"	120"	
Regular Cordless	221	232	247	271	293	305	321	332	345	379	408	-	-	
Cordless Top Down Bottom Up	350	367	392	428	462	482	511	529	552	591	747	-	-	
Clutch	101	111	118	124	134	143	146	153	158	168	179	190	205	
Clutch Top Down Bottom Up	185	203	217	229	246	263	270	281	291	310	330	349	378	
Non moveable arch, quarter arch, and circle	10%													
Moveable trapezoid and octagon	50%													
Slider - Left Stack & Right Stack	100%													
Slider - Center Split	120%													

Manufacturer's suggested retail price

NET Surcharges	Details
Top down corded (72" maximum width and drop)	\$16.00 per shade
Top Down Bottom Up corded (72" maximum width and drop)	\$16.00 per shade (fabric insert included)
Skylight	\$27 per shade plus cost of the corded shade
Day/Night Shade- two colors with top & bottom	Charged as a combination of two shade prices
Tile cut out (no warranty for cut out)	\$11.00 per side
2-on-1 & 3-on-1 head rail	The shades are priced individually
Top Light Blocker (white only)	\$1.16/ per ft. The top light blocker, one piece per shade, will be cut to the shade ordered width. No deduction.
Side Light Blocker (white only)	\$1.56/ per ft. The side light blockers, two pieces per shade, will be cut to the shade order height. No deduction.

Notes: 3-on-1 head rail is not available for clutch control.

NET Surcharges

Size Limitation - for Cell-In-A Cell fabric only

	Corded	Cordless	Corded TDBU	Cordless TDBU	Clutch	Clutch TDBU
Minimum Width	7"	12"	12"	19"	12"	23"
Maximum Width	120"	95"	72"	83"	120"	120"
Maximum Height	83"	83"	72"	83"	83"	83"

Note: The Cell-in-A Cell fabric is not available in the Skylight and in the Slider shades.

Size Limitation - for all fabrics except Cell-in-A Cell

	Corded	Cordless	Corded TDBU	Cordless TDBU	Clutch	Clutch TDBU	Skylight	Slider
Minimum Width	7"	12"	12"	19"	12"	23"	16"	24"
Minimum Height	10"	10"	10"	10"	10"	10"	10"	24"
Maximum Width	144"	96"	72"	96"	120"	120"	60"	120"
Maximum Height	144"	84"	72"	84"	120"	120"	60"	132"

Standard Features:

- 1/4" deduction will be taken for inside mount
- Aluminum headrail and bottom rail
- Right cord control
- Cord length is defaulted no more than 40% of shade drop height.
- Cord cleat is included for the corded shades

Day/Night Shade Features:

- Made with HT standard aluminum headrail and bottom rail
- The color of the top rail will match the top fabric; the middle and bottom rail will match the bottom fabric.
- The light filtering fabric on the top area, the blackout fabric on the bottom area.
- Standard control: right cord operates the bottom rail; left cord operates the middle rail. Reverse controls are also available.
- Cord length is defaulted no more than 40% of the shade drop height.
- Cordless control is available.
- Maximum size is 72"W x 72"H for both corded and cordless shades.

Skylight Shade Features:

- Skylight can only be mounted inside
- Finished size **must** be provided
- Color coordinated headrails, middle rails, bottom rails and fabrics
- The headrail including the end caps is 5/8" less than the finished size.
- the side rails are available in the color *white (001) only*
- Skylight poles are available in 2 options (ordered separately):
 - 3ft-5ft: \$17 each
 - 5ft-9ft: \$23 each
- **No deductions will be taken by the manufacturer**

Features

- To match other cellular shades in the home
 - Ideal for the patio doors, wide windows, and room dividers
 - The finished shades are available in **Left Stack**, **Right Stack**, and **Center Split**
 - Aluminum headrail and side rails are available in white color.
 - Integrated headrail. No valance needed.
 - Cordless design
 - Handle position is about the center of the moving rail.
 - Fabrics available in the most of the HT cellular fabrics*.
- * **NOTE** - The cellular slider shade is unavailable in the 9/16" linen print, 3/4" Cell-In-A Cell, and 7/16" double cell fabrics.

Prices

	Add to the regular corded shade price	Equal to Multiplier
Left Stack and Right Stack	100%	2
Center Split	120%	2.2

Size Limitation

Minimum Width	Minimum Height	Maximum Width	Maximum Height
24"	24"	120"	132"

Stack Width

	Left Stack	Right Stack	Center Split
Minimum Width	5-1/4"	5-1/4"	10-1/2"
Maximum Width	5-5/8"	5-5/8"	11-1/4"

Deductions

	Width	Height
Inside Mount	1/4"	1/2"
Outside Mount	No deductions	

Minimum mounting space

	Minimum Mounting Depth	Minimum Flush Mount Depth
Inside Mount	2-3/4"	4"
Minimum Flat Vertical Surface		
Outside Mount	2-1/4"	



Insulating
Energy saving \$



Cordless design



Easy to install

Fabric options include most of the cellular fabrics* in both light filtering and blackout selections.

Systems available in Left Stack, Right Stack, and Center Split

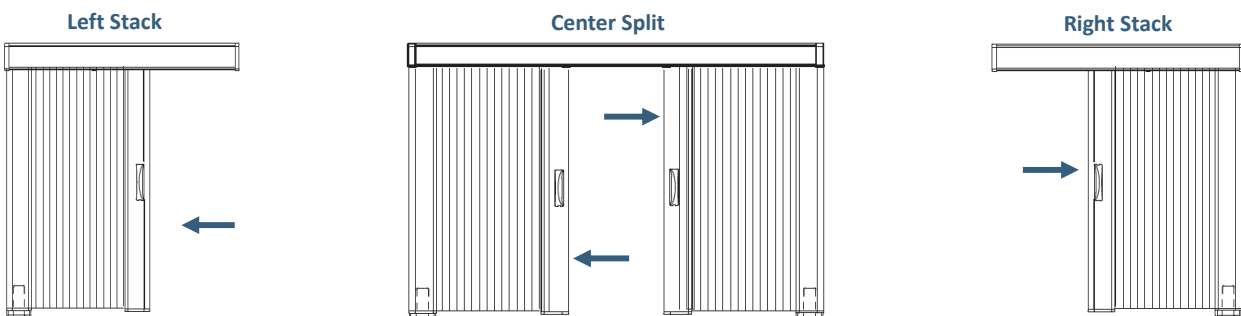

NOTES

- The stationary rail bottom bracket (floor bracket) can be mounted to the floor or side walls. The extension bracket is available when requested.
 - To mount the stationary rail bottom bracket (floor bracket) to the floor, the distance between the floor and the bottom of the shade can not be bigger than 1-1/2".
- * The fabric selections for the slider shades are unavailable in 9/16" linen print, 3/4" cell-in-a cell, and 7/16" double cell fabrics.

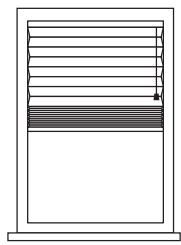

Standard

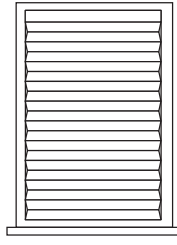

Cordless

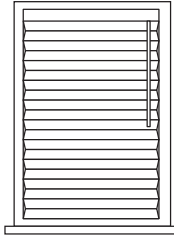

Clutch

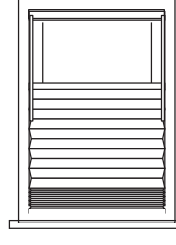

Clutch Top Down Bottom Up

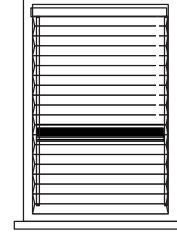

Clutch Day/Night

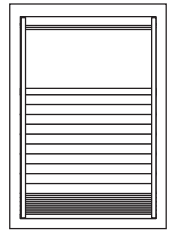

Skylight

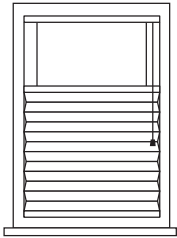

Top Down

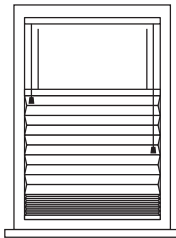

Corded Top Down Bottom Up

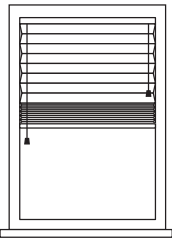

Cordless Top Down Bottom Up

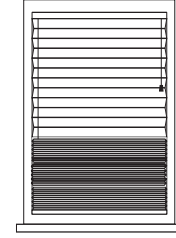
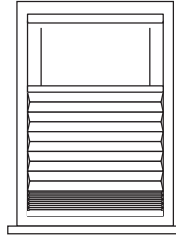

Corded Day/ Night

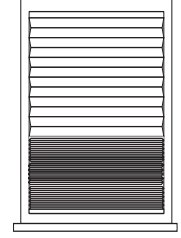

Cordless Day/Night

Cellular shade collection

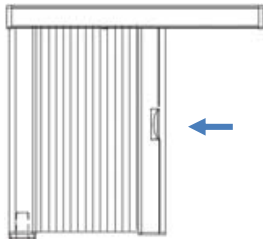

Standard Slider - Side Stack

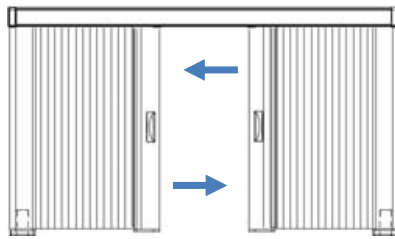

Slider - Center Split

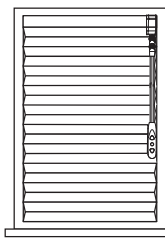

Simple Touch® Wand

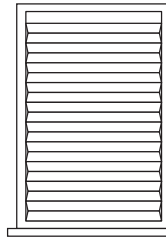

Simple Touch® Remote

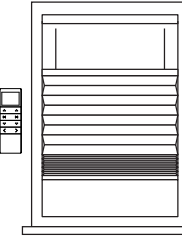

Simple Touch® Top Down Bottom Up

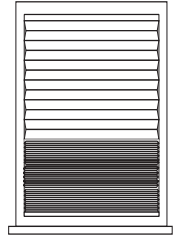

Simple Touch® Day/ Night

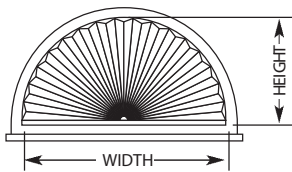

Standard Arch

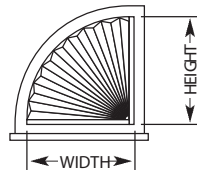

Half Arch

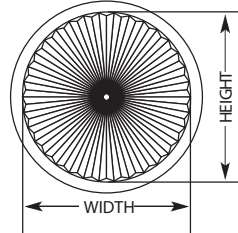

Circle

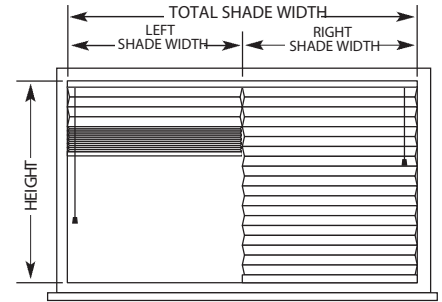

2-on-1 Headrail

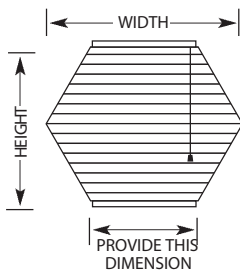

Hexagon

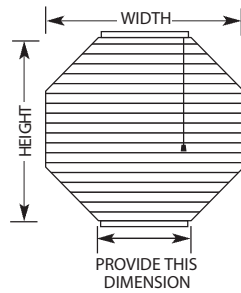

Octagon

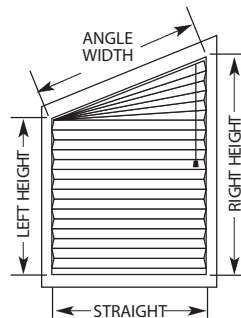

Trapezoid

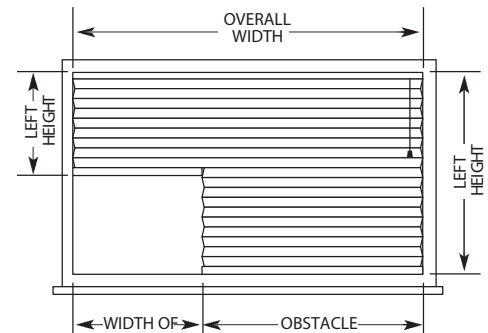

Cutout

Perfect Arches (Do not require a template)

Perfect Arches are those where the radius of the circle is consistent at all points.

Non-perfect Arches (Require Templates)

Non-perfect Arches are not consistent at all points. Deviation of even 1/16" makes it imperfect.

ARCHES

Width	MINIMUM = 18"	MAXIMUM = 84"
Height	MINIMUM = 9"	MAXIMUM = 48"

Non-movable arches

Non-perfect arches require templates

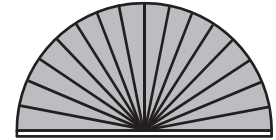

QUARTER ARCHES

Width	MINIMUM = 9"	MAXIMUM = 50"
-------	--------------	---------------

Non-movable quarter arches

Non-perfect quarter arches require templates.

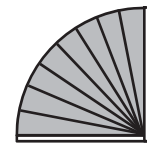

CIRCLES

Width	MIN 9/16" = 9"	MAX 9/16" = 42"
Width	MIN 7/16" = 12"	MAX 7/16" = 42"

Non-movable circles

Non-perfect circles require templates.

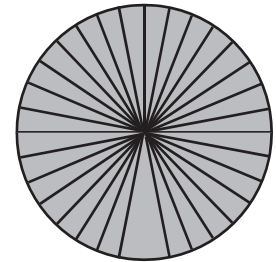

OCTAGONS

Width	MINIMUM = 12"	MAXIMUM = 48"
Height	MINIMUM = 12"	MAXIMUM = 48"

Measurement of all 8 sides are needed.

Templates are required.

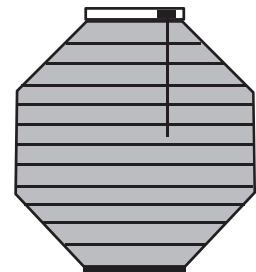

TRAPEZOIDS

Width	MINIMUM = 12"	MAXIMUM = 60"
Height	MINIMUM = 12"	MAXIMUM = 72"

Longer side drop can not exceed 130% of shorter side drop.

Measurement of all 4 sides are needed.

Specialty cellular shades are not available for sky lights.

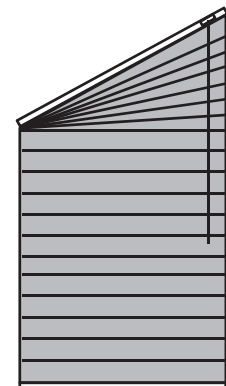

Simple Touch® Wand motorized shade is operated by 8 AA batteries. The motor can support a shade up to 9 lbs. This unique cordless, battery powered shade has a control on a wand handle. Consumers do not need to worry about where the remote control is. Simple Touch® Wand cellular shades are made with the heavy duty headrail and finest cellular shade fabrics. We offer a variety of options for the consumers' convenience. The shade has the standard setup of upper limit and lower limit.

NET SURCHARGE (ADDED TO THE CORDED PRICE)	\$	55
--	-----------	-----------

OPTIONAL HARDWARE	NET SURCHARGE	
Power adaptor (with 70" cord)	\$	12
8 Alkaline AA batteries	\$	5.5
8 Lithium AA batteries	\$	16
Power extension cord (118")	\$	5.5

SIZE LIMITATION:

	Single cell light filtering	Single cell blackout	Double cell light filtering
Minimum Width	28"	28"	28"
Minimum Height	12"	12"	12"
Maximum Width	118"	118"	96"
Maximum Height	118"	118"	118"
Maximum Weight	9Lbs	9Lbs	9Lbs



WAND:

- Standard: half of the drop of the shade
- Wand is clear with white cord inside
- Minimum wand length: 12"
- Maximum wand length: 60"

***NOTE:** Standard wand control is on the right side unless specified.

POWER OPTIONS:

- Complimentary 8 AA Alkaline batteries are included. Lithium batteries are recommended for durability.
- Power adaptor - 70" cord including cord length inside the headrail.
- Replacing the batteries does not affect current shade set up.

***NOTE:** Battery life expectancy is estimated around 1 year for Alkaline battery (depending on frequency of operation and material weight). For example, a 72"x72" single cell light filtering shade can go on 500 operation cycles. Lithium batteries last longer than Alkaline batteries.

BATTERY REPLACEMENT:

When Alkaline batteries are running low, shade will start to operate at a slower speed; indicating a replacement of new batteries are needed.

BATTERY BOX LOCATION:

- Standard: inside the headrail without battery box cover
- Outside the headrail: Battery box can be installed outside the headrail.
- Battery box cover is needed when the battery box is moved outside the headrail. Cover is included in the hardware bag.

- *NOTES:**
1. When the battery box is moved to outside of the headrail, the cord can go through between the headrail and window frame.
 2. When moving battery box outside of the headrail, the minimum width can be reduced to 24"W. (Optional)
 3. Extension cord (optional) is available if needed. Extension cord is ordered separately.

COLOR COORDINATION:

- Simple Touch® Wand cellular shade follows our standard color coordination chart
- Color coordinated headrail, bottomrail, and end caps

UPPER LIMIT, LOWER LIMIT AND FAVORITE POSITION:

Simple Touch® Wand cellular shade is preset with upper position at 0", and lower position at ordered drop.
Consumers can set up favorite position followed by the instruction on www.htwfonline.com.

INSTALLATION:

Simple Touch® Wand cellular shade is installed with heavy duty brackets. Installation instruction and programming guide is included in the hardware bag.

WARRANTY:

Standard HT warranty on cellular shade - 3 years for the Simple Touch® Wand shade

Simple Touch
Wand

The **Simple Touch®** Remote control motorized shade is operated by 8 AA Lithium batteries. It's operated by a 15-channel remote. The motor can support a shade up to 15 lbs. This motorized shade comes with 8 AA lithium batteries. It is an economical option to meet your budget. The operation system also comes with options of top down bottom up and Day/ Night. The Simple Touch® remote cellular shades are made with the heavy duty headrail and finest cellular shade fabrics. The shade has features of setting upper limit, lower limit, and your favorite position. The motorized shade will be programmed with top limit and bottom limit before ship out. The programming instructions are available on www.htwfonline.com.

REMOTE, TOP LIMIT, BOTTOM LIMIT, AND MY FAVORITE POSITION

Simple Touch® Remote Regular Cellular Shade

- Top limit is preset with upper position at the very top.
- The bottom limit is preset with a lower position at ordered drop.
- Controlled by a 15-channel remote, please see image at right.

Simple Touch® Remote Top Down Bottom Up and Day/ Night Cellular Shades

- Top limit is preset with both middle and bottom rails at the very top position.
- The bottom limit is preset with both middle and bottom rails at a lower position at ordered drop.
- Controlled by a 15-channel remote, please see image at right.
- This Simple Touch® Remote can control the middle rail and the bottom rail individually or together at the same time.
- The right buttons on the Simple Touch® Remote are designed to control the middle rail. The left buttons control the bottom rail.



My favorite position can be set up followed by the programming instruction on www.htwfonline.com.

SURCHARGES	NET
Simple Touch® Regular Motorized Shade (added to the corded price)	\$ 95
Simple Touch® Top Down Bottom Up Motorized Shade (added to the corded price)	\$ 110
Simple Touch® Day/ Night Motorized Shade (added to the corded Day/ Night price)	\$ 110

REMOTE CONTROL	NET
Simple Touch® 15 channel remote (for the regular shades)	\$ 27
Simple Touch® 15 channel remote (for the Top Down Bottom Up and Day/ Night)	\$ 37

OPTIONAL HARDWARE	NET
Power adaptor (with 70" cord)	\$ 12
8 Lithium AA batteries	\$ 16
Power extension cord (118")	\$ 5.5



SIZE LIMITATION: Maximum weight is 15 lbs.			
Minimum width for the regular motorized shade	28"	Minimum drop	12"
Minimum width for the Top Down Bottom Up and Day/ Night motorized shades	44"	Maximum drop for single cell	96 sq. ft
Maximum width	120"	Maximum drop for double cell	75 sq. ft

Note - Optional minimum width for the Top Down Bottom Up and Day/ Night cellular shade can be reduced to 40" when moving the battery box outside of the headrail.

POWER OPTIONS:

- Standard: 8 AA Lithium batteries are included.
- Option: Power adaptor (order separately) - 70" cord which includes the length inside the headrail.

NOTE - Replacing the batteries does not affect the current shade set up.

BATTERY BOX LOCATION:

Standard - inside the headrail without the battery box cover

- Option (outside the headrail) is upon request. The battery box can be installed outside the headrail.
 - The battery box can be installed outside the headrail. The box cover is required when the battery box is located outside of the headrail.
 - The battery box cover is included in the hardware bag.

NOTE: The battery box cover is only used when the battery box is located outside of the headrail. The cord can go through between the headrail and the window frame. The extension cord (optional) is available if needed. The extension cord is ordered separately.

COLOR COORDINATION:

- Simple Touch® cellular shade follows our standard color coordination chart
- Color coordinated fabric, headrail, bottomrail, and end caps.

FABRIC OPTIONS:

Simple Touch® system is available for all HT cellular shade fabrics.

INSTALLATION:



Simple Touch® remote cellular shade is installed with the heavy duty brackets. Installation instruction is included in the hardware bag.

WARRANTY:

Standard HT warranty on cellular shade - 3 years for the Simple Touch® Remote Shades

Somfy Motorized Custom Cellular Shades, myLink, and Rechargeable Battery Pack

The HT's motorized cellular shades are also offered with Radio Technology Somfy (RTS) system. It is operated by a battery powered motor. The battery life expectancy is 1 to 3 years (depending on the frequency of operation and the material weight). The remote control is supported by the radio frequency control. It can be controlled as a subgroup or as an entire group; depending on your choice of the remote control.

Somfy Motorized Cellular Shades	
Standard features	Upgrade features
<ul style="list-style-type: none"> • Reloadable battery tube and 8 AA Lithium batteries are included • 1-1/2" color coordinated headrail • Handheld remote control only (no hardwire) • Radio frequency control • Wall mount clips are included. • Can work with myLink to be a smart shade • Flash depth including the headrail and battery tube is 3".  <p>Somfy reloadable battery tube</p>	<ul style="list-style-type: none"> • Li-ion rechargeable battery pack and charger are included • 1-1/2" color coordinated headrail • Handheld remote control only (no hardwire) • Radio frequency control • Wall mount clips and headrail mount clips are included. • Can work with myLink to be a smart shade • Flash depth including the headrail and battery pack is 3-1/4". • Please read Somfy Rechargeable Battery Pack Instruction carefully before installing and before using the battery. You can also find the hard copy inside the package of the battery pack.  <p>Somfy rechargeable battery pack</p>  <p>Somfy recharger (w/ 80" cable)</p>

SURCHARGES (ADDED TO THE CORDED PRICE)	NET
Standard feature - with reloadable battery tube	\$ 205
Upgrade feature - with rechargeable battery pack & charger	\$ 225
Radio frequency transmitter: 1 channel	\$ 52
Radio frequency transmitter: 5 channel	\$ 68
Radio frequency transmitter: 16 channel	\$ 210

Hand Held Remote Control (3 options):

- Option 1: A single channel RTS remote controls one Somfy motorized cellular shade individually.
- Option 2: A 5-channel RTS remote controls up to five individual Somfy motorized cellular shades or five groups of the motorized shades.
- Option 3: A 16-channel RTS remote controls up to 16 individual Somfy motorized cellular shades or 16 groups of the shades.



Somfy

OPTION HARDWARE	NET
myLink	\$ 190
Reloadable battery tube (requires but not includes 8 AA lithium batteries)	\$ 20
8 Lithium AA batteries	\$ 16
48" motor extension cable	\$ 7
96" motor extension cable	\$ 9
Wall mount clip for the reloadable battery tube (set)	\$ 5
Rechargeable battery pack	\$ 38.0
Charger (for the rechargeable battery pack) with 80" cord	\$ 12.0
94.5" charger extension cable	\$ 5



SIZE LIMITATION

Minimum width	20"	Maximum width	120"
Minimum height	12"	Maximum height	120"

Color Matching:

To ensure color matching, all cellular shades must be ordered at the same time. This will eliminate the possible variations due to the nature of the fabric. Product availability is subject to change without notice.

Have a question about Somfy programming or myLink app? Somfy tech team can help you. Call Somfy at **(800) 227-6639** Monday through Friday from 8am to 5pm or email to technicalSupport_us@somfy.com.

Single Cell Light Filtering			
48-INCH DROP		72-INCH DROP	
WIDTH	PRICE EACH	WIDTH	PRICE EACH
30"	\$ 53	30"	\$ 60
38"	\$ 64	38"	\$ 72
54"	\$ 84	54"	\$ 94
72"	\$ 117	72"	\$ 128

Single Cell Blackout			
48-INCH DROP		72-INCH DROP	
WIDTH	PRICE EACH	WIDTH	PRICE EACH
30"	\$ 78	30"	\$ 86
38"	\$ 97	38"	\$ 110
54"	\$ 130	54"	\$ 147
72"	\$ 175	72"	\$ 201

Manufacturer's Suggested Retail Price

FEATURE:

- Available in 10 fabrics (both light filtering and blackout)

Light Filtering

- o 9/16" Single LF Cell Cotton (1G001)
- o 9/16" Single LF Cell Winter White (1G070)
- o 9/16" Single LF Cell Fawn (1G006)
- o 9/16" Single LF Cell Antique Pewter (1G346)
- o 9/16" Single LF Cell Anthracite (1G030)

Blackout

- o 9/16" Single BO Cell Cotton (2G001)
- o 9/16" Single BO Cell Winter White (2G070)
- o 9/16" Single BO Cell Fawn (2G006)
- o 9/16" Single BO Cell Antique Pewter (2G346)
- o 9/16" Single BO Cell Anthracite (2G030)

- State-of-the-Art Vinyl Head/Bottom Rail System
- Easy to Install Hidden Brackets
- Label width is actual dimension of the shade, no deduction
- 100% Polyester Spun Lace Non-woven Fabric
- 6Pcs / master case

SURCHARGE: (Net surcharge, no discount)

- Cut Width : (Cut down width has 1/4" deduction for the inside mount).
- Will Not Shorten Height

\$ 4.75/PC

TRIM ALLOWANCES

- Width : 30"
- Width : 38"
- Width : 54"
- Width : 72"

MAXIMUM CUT

- Total 12": 6" from each side
- Total 8": 4" from each side
- Total 16": 8" from each side
- Total 18": 9" from each side

- o 9/16" Single LF Cell White Dove (1G069)
- o 9/16" Single LF Cell Gray Sheen (1G021)
- o 9/16" Single LF Cell Misty Gray (1G514)
- o 9/16" Single LF Cell Warm Cocoa (1G492)
- o 9/16" Single LF Cell Sticks & Stones (1G519)

- o 9/16" Single BO Cell White Dove (2G069)
- o 9/16" Single BO Cell Gray Sheen (2G021)
- o 9/16" Single BO Cell Misty Gray (2G514)
- o 9/16" Single BO Cell warm cocoa (2G492)
- o 9/16" Single BO Cell Sticks & Stones (2G519)

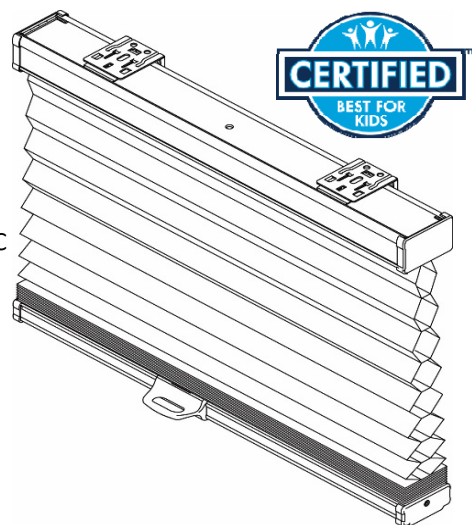

Single Cell Light Filtering			
48-INCH DROP		72-INCH DROP	
WIDTH	PRICE EACH	WIDTH	PRICE EACH
30"	\$74	30"	\$82
38"	\$85	38"	\$93
54"	\$114	54"	\$125
72"	\$160	72"	\$173

Single Cell Blackout			
48-INCH DROP		72-INCH DROP	
WIDTH	PRICE EACH	WIDTH	PRICE EACH
30"	\$100	30"	\$108
38"	\$124	38"	\$140
54"	\$159	54"	\$178
72"	\$216	72"	\$243

Manufacturer's Suggested Retail Price

FEATURE:

- Available in 10 fabrics (both light filtering and blackout)

Light Filtering

- o 9/16" Single LF Cell Cotton (1T001)
- o 9/16" Single LF Cell Winter White (1T070)
- o 9/16" Single LF Cell Fawn (1T006)
- o 9/16" Single LF Cell Antique Pewter (1T346)
- o 9/16" Single LF Cell Anthracite (1T030)
- o 9/16" Single LF Cell White Dove (1T069)
- o 9/16" Single LF Cell Gray Sheen (1T021)
- o 9/16" Single LF Cell Misty Gray (1T514)
- o 9/16" Single LF Cell Warm Cocoa (1T492)
- o 9/16" Single LF Cell Sticks & Stones (1T519)

Blackout

- o 9/16" Single BO Cell Cotton (2T001)
- o 9/16" Single BO Cell Winter White (2T070)
- o 9/16" Single BO Cell Fawn (2T006)
- o 9/16" Single BO Cell Antique Pewter (2T346)
- o 9/16" Single BO Cell Anthracite (2T030)
- o 9/16" Single BO Cell White Dove (2T069)
- o 9/16" Single BO Cell Gray Sheen (2T021)
- o 9/16" Single BO Cell Misty Gray (2T514)
- o 9/16" Single BO Cell warm cocoa (2T492)
- o 9/16" Single BO Cell Sticks & Stones (2T519)

- State-of-the-Art Vinyl Head/Bottom Rail System
- Easy to Install Hidden Brackets
- Label width is actual dimension of the shade, no deduction
- 100% Polyester Spun Lace Non-woven Fabric
- 6Pcs / master case

SURCHARGE: (Net surcharge, no discount)

- Cut Width : (Cut down width has 1/4" deduction for IB).
- Will Not Shorten Height

\$ 4.75/PC

TRIM ALLOWANCES

- Width : 30"
- Width : 38"
- Width : 54"
- Width : 72"

MAXIMUM CUT

- Total 7": 3.5" from each side
- Total 8": 4" from each side
- Total 16": 8" from each side
- Total 18": 9" from each side

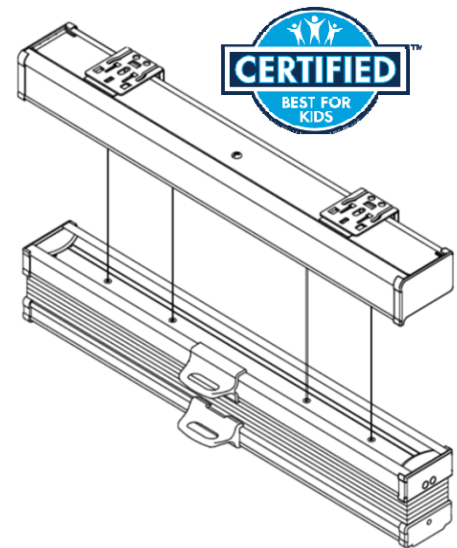

Single Cell			
48-INCH DROP		72-INCH DROP	
WIDTH	PRICE EACH	WIDTH	PRICE EACH
30"	\$ 114	30"	\$ 135
38"	\$ 143	38"	\$ 168
54"	\$ 190	54"	\$ 227
72"	\$ 263	72"	\$ 305

Manufacturer's Suggested Retail Price

FEATURE:

- Available in 10 fabrics

- o 9/16" Single LF/BO Cell Cotton (1D001)
- o 9/16" Single LF/BO Cell Winter White (1D070)
- o 9/16" Single LF/BO Cell Fawn (1D006)
- o 9/16" Single LF/BO Cell Antique Pewter (1D346)
- o 9/16" Single LF/BO Cell Anthracite (1D030)
- o 9/16" Single LF/BO Cell White Dove (1D069)
- o 9/16" Single LF/BO Cell Gray Sheen (1D021)
- o 9/16" Single LF/BO Cell Misty Gray (1D514)
- o 9/16" Single LF/BO Cell Warm Cocoa (1D492)
- o 9/16" Single LF/BO Cell Sticks & Stones (1D519)

- Single Cell Light Filtering On Top and Blackout On Bottom
- State-of-the-Art Vinyl Head/Bottom Rail System
- Easy to Install Hidden Brackets
- Label width is actual dimension of the shade, no deduction
- 100% Polyester Spun Lace Non-woven Fabric
- 6Pcs / master case

SURCHARGE: (Net surcharge, no discount)

- Cut Width : (Cut down width has 1/4" deduction for IB). \$ 4.75/PC
- Will Not Shorten Height

TRIM ALLOWANCES

- Width : 30"
- Width : 38"
- Width : 54"
- Width : 72"

MAXIMUM CUT

- Total 7": 3.5" from each side
- Total 8": 4" from each side
- Total 16": 8" from each side
- Total 18": 9" from each side

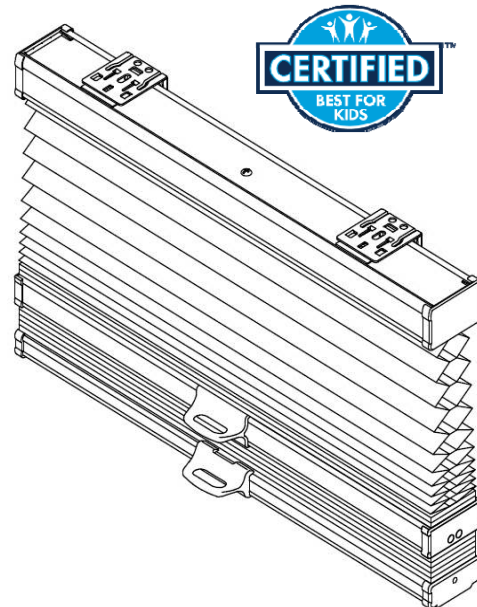

Simply Cordless
Day/Night

Measure each window individually as sizes may vary. Measure width first, then height (length) to the nearest 1/8". Measure width from left to right, height from top to bottom using a metal tape measure. **PLEASE DO NOT USE A CLOTH TAPE!**

Inside Mount:

Inside mount shades are installed inside the window frame.

1. Measure the exact inside width of the window frame from one inside edge to the other. Take three measurements - one near the top, one in the center, and one near the bottom. Record the narrowest measurement.
2. Measure the exact height in three places: left, center and right from top edge of opening to top of sill. Record the longest measurement for horizontal blinds.
3. Do not take deductions on inside mount measurements. The factory will take an 1/4" allowances for operating clearance.
4. Measure the window diagonally in two places as shown. If the two diagonal measurements are not the same, we suggest an outside mount application for the best shade performance and appearance.

Outside Mount:

Outside mount shades are installed outside the window frame, covering an area larger than the window itself.

1. Measure the exact width of the area to be covered. Be certain the measurement overlaps the window opening by at least 1-1/2" on each side to ensure privacy and light control.
2. Measure exact height to be covered, including desired overlap (usually from top edge of molding to bottom edge, or to top of sill). If there is no sill, measure to where the blind is to reach.
3. The factory does not make deductions for an outside mount.

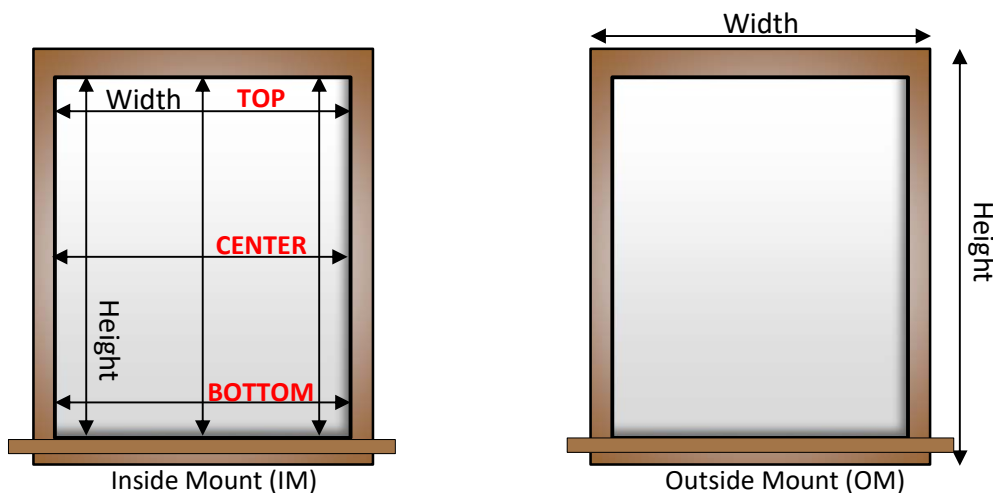

For more questions about how to measure your window, please contact HT customer service at 1-800-879-9512.

! WARNING/ADVERTENCIA	
	<p>Window blind cord can STRANGLE your child. To prevent strangulation, purchase cordless products or products with inaccessible cords.</p> <p>La cuerda de la persiana puede ESTRANGULAR a su niño. Para evitar el estrangulamiento, compre alternativas cuerda o productos con cuerdas inaccesibles.</p>

What is covered by warranty:

- Warranty is offered to the original owner.
- Warranty applies only to the products properly installed in the window for where they were intended, following the installation instruction, care guide, programming instruction, and recommendations from HT window fashion.
- Warranty covers the products made and assembled solely with HT original material.
- Warranty will repair or replace the product solely at HT's option due to defective material or poor workmanship.
- This warranty gives you specific legal rights and you may also have other rights, which vary from the state to state.

What is not covered by warranty:

- This warranty does not apply to any HT products damaged by accident, misuse, abuse, direct exposure to salty air or improper moisture, discoloration due to sunlight, under exposure or irregular temperature.
- This warranty does not apply to conditions caused by normal wear and tear upon the product. It does not apply to any product damaged by fire, flood, wind, rain, lightning, or other act of nature environment.
- In no event shall HT be liable for incidental or consequential damage, loss, cost, expense or fee.
- Warranty does not apply to liquidated or discontinued items.
- Warranty does not include shipping charges.

Shipping and return fees:

- Within 6 months -
HT pays for return on the repairs within 6 months of receipt of the products. HT will ship the products back to the customers for free.
 - From 6 months to 3 years (the warranty period) -
The customers are responsible for the return shipping. HT will cover the repair cost and ship it back for free.
 - After the warranty expired -
The customers are responsible for all shipping and repairing charges.
- * **NOTE** - The free shipping and return are valid for GROUND service only.

How to obtain warranty service:

Please contact HT Window Fashions customer service with the following information:

- Original sales receipt
- Model and identification numbers
- Detail description of defect

Product	Aluminum Blinds	Cellular Shade	Verti-Sheer Shades
Warranty	Limited lifetime 3 years on the cord and cord lock	Limited Lifetime 3 years on the fabric, cord and cord lock	Limited Lifetime 3 years on the fabric



HT Window Fashions™ is your one-stop destination for all your contract needs.
We specialize in aluminum blinds and cellular shades.
We will configure the program and quote to fit your budget, time and special needs.

We offer:

- Quick Ship - customized or custom fabrication – shipped in 7-10 business days or less*
- Cross Dock - overseas production – 75 days*
 - o Direct Import pricing on full and partial container quantities

**Lead times are confirmed based on the order size, special needs, and production schedule.*

It is as easy as 1-2-3

1 Submit your quote request via email, fax or phone with attention "Sales Quote"

Email address	emailorder@richview.com
Fax	626-839-8861
Toll Free	800-879-9512

We encourage you to submit quote request via email for better accuracy.

2 Our quote specialist will work with you on special needs such as products, packaging, and pricing during your bidding time.

The confirmation will be emailed back within 24 hours.

3 Please review your quote and confirm it via email or fax to give us your approval. The customer service will convert it to an order and process.

Terms:

- Minimum Order Quantity (MOQ) for the contractor quote is 15 units.
- All contract quotes are guaranteed for 90 days.
- When and if necessary - the quote older than 90 days are the subject to a 0.5% price adjustment per month, subject to the material cost increases.
- Deposit may be required.

Please reach out the Contract Department for your quote.

Email address	emailorder@richview.com
Fax	626-839-8861
Toll Free	800-879-9512

770 S. Epperson Dr.
 City of Industry, CA 91748
 (626) 839-8866 (800) 879-9512
 (626) 839-8861 Fax
WWW.HTWFONLINE.COM

New Customer Application

Legal Entity:

- Sole Proprietor
- Corporation
- Partnership
- Limit Liabilities Company (L.L.C.)
- Other _____

Business Operated From:

- Retail Store Front
- In-Home Business
- Industrial Center
- eCommerce

RICHVIEW OFFICE USE ONLY

Acct #:
Terr #:
Approval:

Estimated Monthly Purchases: \$ _____ # Locations: _____ # Employees: _____

General Information

Legal Name	_____	Phone	_____
Trade Name (DBA)	_____	Fax	_____
Address	_____	Website	_____
City, State, Zip	_____	E-Mail	_____
Years in Business	_____	Fed.ID	_____

Personal Information of President, Owner, CEO, Partners

Name & Title	_____	Name & Title	_____
Home Address	_____	Home Address	_____
City, State, Zip	_____	City, State, Zip	_____
Cell/E-mail	_____	Cell/E-mail	_____
Social Security	_____	Social Security	_____

Bank References

Name	_____	Name	_____
Address	_____	Address	_____
City, State, Zip	_____	City, State, Zip	_____
Account No.	_____	Account No.	_____
Phone	_____	Phone	_____
Fax/E-Mail	_____	Fax/E-Mail	_____

The undersigned hereby authorize HT window fashions™ to review any information provided for the purpose of establishing credit. It is agreed that the undersigned will hold harmless the companies engaging in the exchange of such information and understands that the information provided is used for credit worthiness as a routine business practice. I also authorize release of my credit information to a credit service agency for the purpose of establishing an account with HT window fashions™.

 Authorized Signature

 Company Name

 Print Name

 Date

IMPORTANT! Application Cannot Be Processed Without Customer Signature

Name	_____
Address	_____
City, State, Zip	_____
Account No.	_____
Phone	_____
Fax/Email	_____

Name	_____
Address	_____
City, State, Zip	_____
Account No.	_____
Phone	_____
Fax/Email	_____

Name	_____
Address	_____
City, State, Zip	_____
Account No.	_____
Phone	_____
Fax/Email	_____

Name	_____
Address	_____
City, State, Zip	_____
Account No.	_____
Phone	_____
Fax/Email	_____

Financial Information

Assets	
Cash	\$ _____
Receivables	\$ _____
Inventory	\$ _____
Fixed Assets	\$ _____
Land	\$ _____
Other Assets	\$ _____
Total Assets	\$ _____

Liabilities	
Accounts Payable	\$ _____
Short Term Debt	\$ _____
Interest Payable	\$ _____
Tax Payable	\$ _____
Long Term Debt	\$ _____
Other Liabilities	\$ _____
Total Liabilities	\$ _____

Requested Terms

- NET 30 Day Terms Certified Funds
 Company Check Credit Card

Note: Orders will be shipped COD until credit is established. First orders over \$500.00 may require prepayment.

By: _____
Authorized Signature
(Print Name)
Date

Personal Guarantee

The undersigned, in consideration of you extending credit at my request to _____ (hereinafter referred to as the "Company") hereby personally guarantee to you payment of any obligation of the Company and I hereby bind myself to pay you on demand any sum which may become due to you by the company whenever the Company shall fail to pay the same. It is understood that this guaranty shall be a continuing and irrevocable guarantee and identity for such indebtedness of the company. I do hereby waive notice of default, non-payment and extension of credit. The undersigned guarantor agrees to pay, in the event the amount becomes delinquent and is turned over to any attorney for collection, attorney's fee and all attendant collection costs. It is understood that this guaranty may be enforced without first having to sue the corporation of business which has incurred the debt. For purposes of the guaranty it is agreed that I will be responsible for the corporate or business debt even though my name does not appear on the invoices or billings.

By: _____
Authorized Signature
(Print Name)
Date

New Account Application

TERMS	Due and payable in full within established time from date of invoice unless otherwise agreed upon in writing.
LATE PAYMENT	Past due amounts are subject to late payment service charges of 1.5% per month, HT reserves the rights to hold customer orders, switch payment terms, submit delinquent account history and information to industry credit agencies, and pursuit legal actions.
NSF CHECKS	A service charge of \$30 will be applied to each returned check.
RETURNS	No returned goods will be accepted without authorization and freight charges must be prepaid by customer. HT does not accept returns other than stock blinds. HT only accepts stock blinds returns when all the following conditions are present: Merchandise (s) with un-opened boxes and not cut downs; HT must receive the return merchandise (s) within 14 days from the invoice date. Note: All returns are subject to a 20% restocking fee.
FREIGHT DAMAGE CLAIMS	Customer assumes full responsibility of all goods when goods are received and signed for by Customer or Agent (including any obvious or hidden freight damage if Supplier is not notified within 48 hours).
TITLE	Title to any and all goods or materials hereafter purchased shall remain with Supplier until the full purchase price has been paid.
FAILURE TO PAY OR INSOLVENCY	Failure by customer to pay any part of the purchase price when due, or in the event that proceeding in bankruptcy, receivership, or insolvency are instituted by or against Customer or his property, supplier may, at its option, cause the entire unpaid balance to become due and immediately payable, and supplier shall have the right to enter at anytime without notice upon the premises where any of the materials purchased by Customer are located. Customer hereby expressly waives any right to action which may occur by reason on the entry for taking possession of or the selling of said materials and agrees to pay all costs incurred with respect thereto including service charges, all 3rd party collection fees, finance charges, reasonable attorney's fees and court costs.
ENTIRE AGREEMENT	This Agreement covers all materials which Customer may hereafter acquire at any time from Supplier. This contract constitutes the entire Agreement with Supplier. No waivers or modifications shall be valid unless the same are in writing and executed by both parties hereto. This contract shall apply and accrue to the benefit of, and be binding upon, the heirs, executors, administrators, successors, and assigns of the respective parties. This Agreement applies to all invoices involving labor, product or services rendered by Tehdex Corp.
LITIGATION	In the event of any litigation arising out of this agreement, Supplier shall be entitled to its reasonable costs and expenses incurred including attorney's fees.
STATE LAWS	This Purchase Agreement shall be governed by the laws of the States of California.
RECEIPT OF A COPY	Customer hereby acknowledges the receipt of a copy of this Agreement at the time of its execution.
By:	_____ Company Name: _____ (signature)
Position:	_____ Date Accepted: _____

New Account Application

Please complete and return form with a copy of your original seller's permit. **All accounts without completed forms will be charged sales tax.**

Name of Purchaser

Address

Address

City, State, Zip

I hereby certify that: I hold valid sellers permit No. _____ issued pursuant to the Sales and Use Tax Law; that I am engaged in the business of selling _____; That the tangible personal property described herein which I shall purchase from HT Window Fashions will be resold by me in the form of tangible personal property provided, however, that in the event of any such property is used for any purpose other than retention, demonstration, or display while holding it for such sale in the regular course of business, it is understood that I am required by Sales and Use Tax Law to report and pay tax, measured by the purchase price of such property.

Description of property to be purchased; _____

By: _____ Print Name: _____
(signature of purchaser or agent)

As: _____ Date Accepted: _____
(position/title)

Phone Number: _____



New Account
Application

Thank you for giving us the opportunity to service your wholesale custom window covering needs. We know you have many choices when it comes to selecting a fabrication source and we will do our best to provide the highest level of quality products and services at the industry's most competitive wholesale prices. We appreciate your taking the time to complete our Customer Application Form in its entirety and we look forward to manufacturing your custom orders.

HT Window Fashions Management

Thank You

HT Window Fashions

770 SOUTH EPPERSON DRIVE

CITY OF INDUSTRY, CA 91748

PHONE (626) 839-8866

(800) 879-9512

Authorization Form Instructions:

*Please Type "Yes" - authorize or "No" - not authorize
(If Yes - continue and sign this form below / If No - stop here)

Contact HT Window Fashions Credit Department with any Question

Credit Card Type: Visa Master Card American Express*

*Note: Due to higher merchant fees, payments made using the AMEX card will incur an added 1.5% processing fee.

Name on the Card: _____

Credit Card Number: _____

Expiration Date: MM/YEAR _____ / _____

AVS: (card security code) _____ For Visa, MasterCard card security code is a 3 digit code printed on the signature strip on the back of the credit card. For American Express, the code is a 4-digit number on the front of the card above the account number.

Person other than card owner authorized to approve credit card payment:

_____**Credit Card Billing Address:**

Street: _____

City: _____

State: _____ Zip Code: _____

Daytime Telephone Number: _____

Evening Telephone Number: _____

 authorize HT Window Fashions Corporation to charge my credit card:

Cardholder's Signature

Date

I authorize Credit Manager to change my terms to Credit Card. Yes No**Orders will automatically be charged to Credit Card.**

Please note: A 1.5% transaction fee will apply to all payments applied to past due balances

Credit Card
Authorization

Ship To:		Request Date: _____
_____		Account #: _____
_____		Company Name: _____
_____		Contact: _____
_____		Email: _____
APPROVED BY: _____		REQUEST ARRIVAL DATE: _____

Samples

LINE ITEM	QTY.	PRODUCT DESCRIPTION	AMOUNT	TOTAL
Cellular Shades				
POLARIS-BK		Cellular sample book classic	\$ 75.00	
POLAR-SB4		Cellular hand sample custom top down bottom up 18x36"	\$ 25.00	
POLAR-SB2		Cellular clutch hand sample 18x24"	\$ 25.00	
POLAR-SB3		Cellular custom cordless hand sample 18"x36"	\$ 30.00	
POLAR-SBTU		Cellular custom cordless top down bottom up 19x36"	\$ 45.00	
POLAR-SBCL		Cellular custom cordless plus 21x36"	\$ 32.00	
POLAR-SBCT		Cellular custom clutch top down bottom up 23" x 36"	\$ 30.00	
POLAR-SBSK		Cellular custom skylight 18"x24"	\$ 30.00	
POLAR-SBPT		Cellular custom Simple Touch® Wand shade 36x36"	\$ 83.00	
PLOAR-SBMT		Cellular custom Simple Touch® Remote shade 36"x36"	\$ 150.00	
POLAR-STTB		Cellular custom Simple Touch® Top Down Bottom Up shade 44"x36"	\$ 180.00	
POLAR-SFMS		Cellular custom Somfy motorized shade 36" x 36"	\$ 280.00	
POLARIS-SC		Cellular Simply cordless swatch card	\$ 12.50	
1G001-4830		Cellular Simply cordless sample shade Light Filtering 30" x 48"	\$ 15.00	
SLID-SD		Cellular custom Slider shade Left Stack 24" x 24"	\$ 45.00	
Cellular Fabrics				
POLAR-BK		Cellular fabric sample book distribution	\$ 75.00	
POLAR-SF02		Cellular fabric sample folder for HT fabrication	\$ 12.00	
POLAR-SF03		Cellular fabric sample folder for distribution	\$ 15.00	
POLAR-SF04		Cellular fabric sample folder for colors for distribution	\$ 20.00	
Sub Total				

Note: The standard fabric on the sample shades above is 9/16" Cotton Light Filtering.

Custom Samples

LINE ITEM	QTY.	PRODUCT DESCRIPTION	AMOUNT	TOTAL

NOTES:

Sample Order Form

POLARIS® CELLULAR SHADES ORDER FORM (STOCK AND CUSTOM)



770 S Epperson Dr City of Industry, CA 91748
 TEL (800) 879-9512
 FAX (626) 839-8861

CUSTOMER ID: _____

CUSTOMER NAME: _____

ORDERED BY: _____

P/O: _____

SIDE MARK: _____

SHIP TO: _____

DATE: _____

QUOTE ID: _____

PHONE: _____

FAX: _____

EMAIL: _____

CHECK WHICH PRODUCT YOU ARE ORDERING

- | | | | |
|--|--|--|--|
| <input type="checkbox"/> 9/16" Single Cell Light Filtering Spun Lace (PLS310) | <input type="checkbox"/> 9/16" Single Cell Blackout Spun Lace (PLS320) | <input type="checkbox"/> 3/4" Single Cell Light Filtering Smooth (PLS43C0) | <input type="checkbox"/> 3/4" Single Cell Light Filtering LUX Linen (PLS47B) |
| <input type="checkbox"/> 9/16" Single Cell Crush (PLS310CR) | <input type="checkbox"/> 9/16" Single Cell Sheer (PLS360) | <input type="checkbox"/> 3/4" Single Cell Blackout Smooth (PLS44C0) | <input type="checkbox"/> Simply Cordless Cellular Shades |
| <input type="checkbox"/> 9/16" Single Cell Light Filtering Linen Point bond (PLS331) | <input type="checkbox"/> 9/16" Fire Retardant Fabrics | <input type="checkbox"/> 3/4" Single Cell Light Filtering Bamboo Print (PLS41R) | <input type="checkbox"/> Simply Cordless TDBU Cellular Shades |
| <input type="checkbox"/> 9/16" Single Cell Light Filtering Slub Woven (PLS37S) | <input type="checkbox"/> 3/4" Single Cell Light Filtering Spun Lace (PLS410) | <input type="checkbox"/> 3/4" Single Cell Blackout Bamboo Print (PLS42R) | Simply Cordless Day/ Night Cellular Shades |
| <input type="checkbox"/> 7/16" Double Cell Light Filtering Spun Lace (PLX3A0) | <input type="checkbox"/> 3/4" Single Cell Blackout Spun Lace (PLS420) | <input type="checkbox"/> 3/4" Single Cell Light Filtering Cell-In-A Cell (PLU41SS) | |

OPTIONS

	FABRIC TYPE	COLOR NAME	COLOR NUMBER	ROOM	QNTY	BLIND SIZE (INCHES)		SHADE TYPE (CHECK ONE)										MOUNT	LIFT	HOLD DOWN	EXT. BRACKETS	SPECIAL INSTRUCTIONS (2-ON-1, DAY/NIGHT, EXTENDED CORD, SPACER, AND ETC.)
						WIDTH	HEIGHT	Regular	Top down bottom up corded	Clutch	Cordless	Top down bottom up cordless	Cordless Plus	Simple Touch™	Skylight	Specialty						
1								Regular	Top down bottom up corded	Clutch	Cordless	Top down bottom up cordless	Cordless Plus	Simple Touch™	Skylight	Specialty	IB	Left	Yes	Yes		
																	OB	Right	No	No		
2								Regular	Top down bottom up corded	Clutch	Cordless	Top down bottom up cordless	Cordless Plus	Simple Touch™	Skylight	Specialty	IB	Left	Yes	Yes		
																	OB	Right	No	No		
3								Regular	Top down bottom up corded	Clutch	Cordless	Top down bottom up cordless	Cordless Plus	Simple Touch™	Skylight	Specialty	IB	Left	Yes	Yes		
																	OB	Right	No	No		
4								Regular	Top down bottom up corded	Clutch	Cordless	Top down bottom up cordless	Cordless Plus	Simple Touch™	Skylight	Specialty	IB	Left	Yes	Yes		
																	OB	Right	No	No		
5								Regular	Top down bottom up corded	Clutch	Cordless	Top down bottom up cordless	Cordless Plus	Simple Touch™	Skylight	Specialty	IB	Left	Yes	Yes		
																	OB	Right	No	No		
6								Regular	Top down bottom up corded	Clutch	Cordless	Top down bottom up cordless	Cordless Plus	Simple Touch™	Skylight	Specialty	IB	Left	Yes	Yes		
																	OB	Right	No	No		
					Total																	

NOTES - Custom Cellular Shade IB Deduction is 1/4".
 - Finished size MUST be provided for Skylight

Page _____ of _____