

Clutch Top Down Bottom Up and Day/Night Cellular Shade Installation and Operation Instruction

IDENTIFY YOUR CELLULAR SHADE AND PARTS

your parts may vary, depending on the custom request, size of the shade, and size of the headrail you are purchasing.

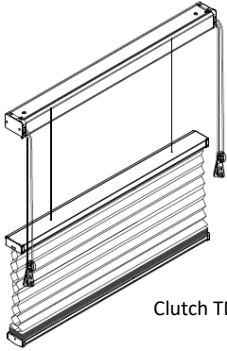

Clutch TDBU cellular shade

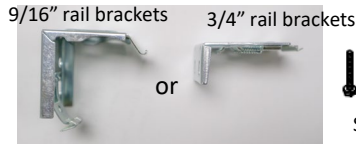

Screws



P clip safety tensioners & screws

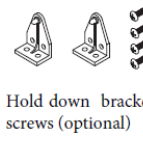

Hold down brackets & screws (optional)

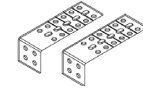

Extension brackets (optional)

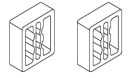

Spacers (optional)

| Shade width | Qty of brackets |
|----------------|-----------------|
| W ≤ 36" | 2 |
| 36" < W ≤ 72" | 3 |
| 72" < W ≤ 96" | 4 |
| 96" < W ≤ 120" | 5 |

TOOLS AND PARTS YOU MAY NEED (not included)

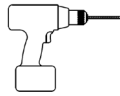

Drill with bits



Metal tape measure



Pen



#4 x 3/4" flat head wood screw



Screwdriver

FOR THE 3/4" RAIL BRACKETS

1. Install the brackets

- Mark the bracket locations, separating the brackets evenly. Make sure all brackets are aligned and level with each other.
- For inside mount - Install the bracket with the hole at top center by using the included screw or with two holes at the top rear side by using #4 x 3/4" flat head wood screws (not included).
- For outside mount – install the bracket with two holes at the back side with included screws.

Use #4 x 3/4" flat head wood screws (not included) for these two holes

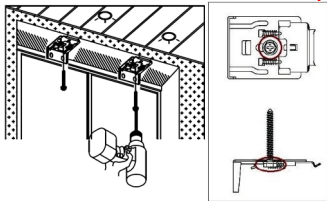

Inside Mount

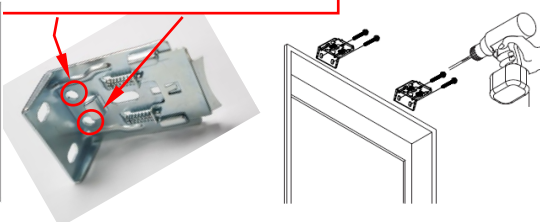

Outside Mount

- Fasten the screws completely.
- Install the shade with the extension brackets (optional)
 - Install the extension bracket with at least 2 screws.
 - Attach the mounting brackets to the extension brackets with the screws.

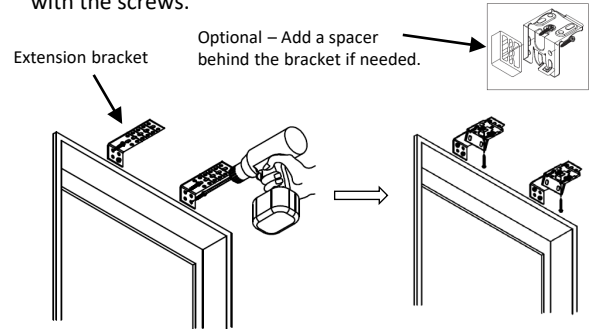

2. Attach the cell shade

- Position the headrail with the front lip resting on the top hooks of all the brackets.
- Push the bottom of headrail firmly upward and toward the window until the groove at the bottom of the headrail snaps into place.

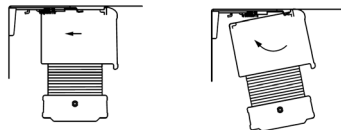

Mounting spaces

- Minimum mounting space – 1/2"
- Flush mounting space
 - 2-1/4" for 9/16" and 7/16" fabrics
 - 2-1/2" for 3/4" fabrics
 - 2-7/8" for 1-1/4" fabrics

3. How to remove the shade from the brackets

- Raise the shade completely. Push the headrail toward to the wall.
- Tilt the backside of the headrail down
- Once the back of the headrail clears the brackets, pull the headrail off the front of brackets.

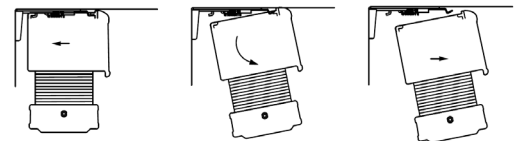

Clutch Top Down Bottom Up and Day/Night Cellular Shade Installation and Operation Instruction

FOR 9/16" RAIL BRACKETS

1. Install the brackets

- Mark the bracket locations, separating the brackets evenly. Make sure all brackets are aligned and level with each other.
- For inside mount - Install the bracket with the holes at top by using the included screws.
- For outside mount – install the bracket with the holes at the back side with included screws.

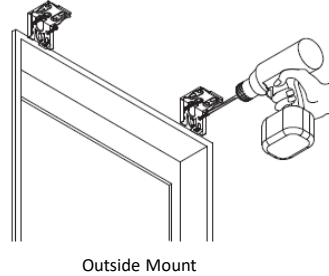
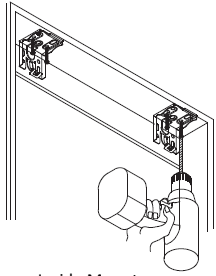

- Fasten the screws completely.
- Install the shade with the extension brackets (optional)
 - Install the extension bracket with at least 2 screws.
 - Attach the mounting brackets to the extension brackets with the screws.

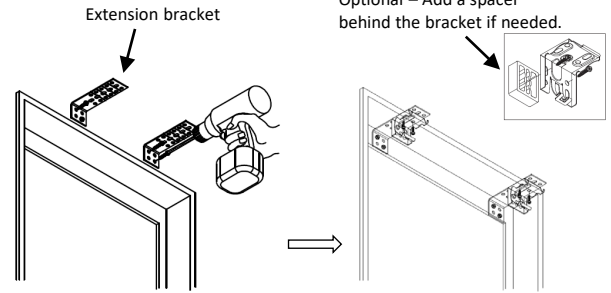

2. Attach the cell shade

- Position the headrail with the front lip resting on the top hooks of all the brackets.
- Push the bottom of headrail firmly upward and toward the window until the groove at the bottom of the headrail snaps into place.

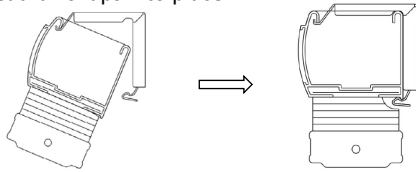

Mounting spaces

- Minimum mounting space – 7/8"
- Flush mounting space
 - 2" for 9/16" and 7/16" fabrics
 - 2-1/8" for 3/4" fabrics
 - 2-1/2" for 1-1/4" fabrics

3. How to remove the shade from the brackets

- Raise the shade completely.
- Use a flat screw to push the bracket tab toward to the wall. Once you hear a "click", then the shade will be released from the bracket.
- Repeat above step to release the shade from other brackets.

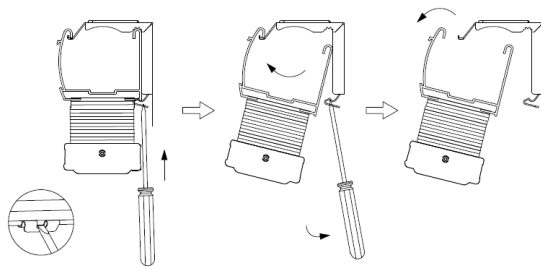

INSTALL THE HOLD DOWN BRACKETS (optional)

- Install the hold down brackets with screws at each side when needed.

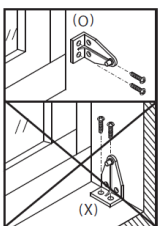

Hold down bracket (optional)

Clutch Top Down Bottom Up and Day/Night Cellular Shade Installation and Operation Instruction

INSTALL THE P CLIP SAFETY TENSIONER

IMPORTANT - THE SHADE WILL NOT OPERATE WITHOUT P CLIP SAFETY TENSIONER PROPERLY INSTALLED. FOR THE SAFETY REASONS, THE CORD LOOP MUST BE SECURE IN THE P CLIP AND HAVE SLIGHT TENSION AT ALL THE TIME.

- Hold the P clip and apply slight tension to the cord loop to determine where to install the P clip.
- Use the screws to install the P clip to the wall. Fasten the screws.
- Check for proper operation of the shade.

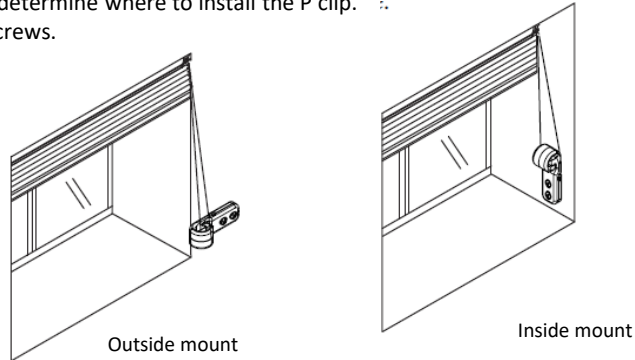

OPERATE THE SHADE

- When lower the shade, pull the right cord to lower the bottom rail first, and then pull the left cord to lower or adjust the location of the middle rail.

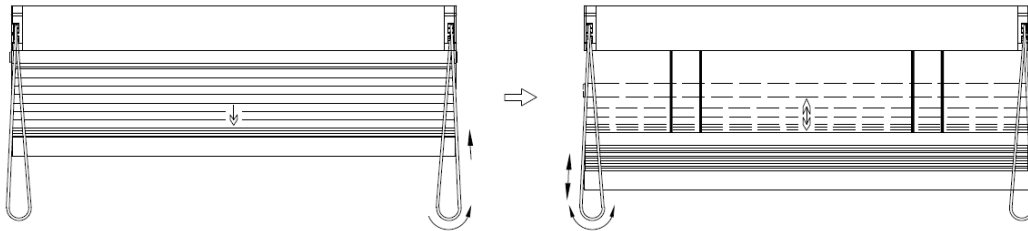

- When raise the shade, pull the left cord to raise the middle rail first, and then pull the right cord to raise the bottom rail.

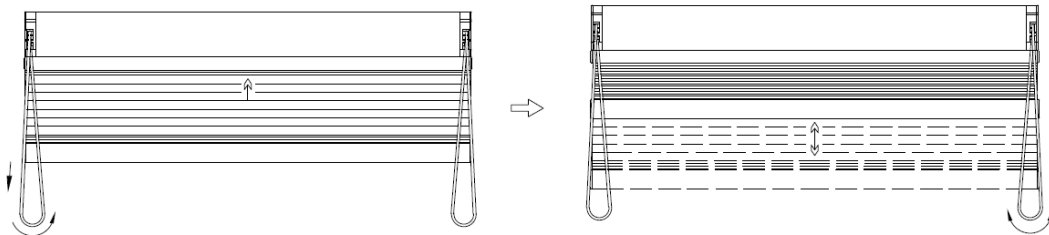

| | |
|---|---|
| ! WARNING/ADVERTENCIA | |
|  | Window blind cord can STRANGLE your child. To prevent strangulation, purchase cordless products or products with inaccessible cords. |
| | La cuerda de la persiana puede ESTRANGULAR a su niño. Para evitar el estrangulamiento, compre alternativas cuerda o productos con cuerdas inaccesibles. |