

Cordless Top Down Bottom Up and Day/Night Cellular Shade Installation Instruction

IDENTIFY YOUR CELLULAR SHADE AND PARTS

your parts may vary, depending on the custom request, size of the shade, and size of the headrail you are purchasing.

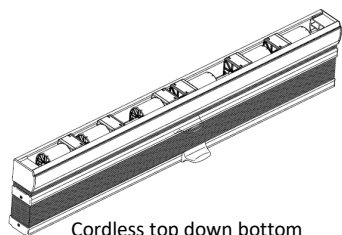

Cordless top down bottom up cellular shade

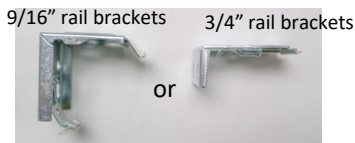

Extension brackets (optional)



Spacers (optional)



screws



Handles

Shade width	Qty of brackets	Qty of handles
$W \leq 36"$	2	1
$36" < W \leq 48"$	3	1
$48" < W \leq 72"$	3	2
$72" < W \leq 96"$	4	2
$96" < W \leq 120"$	5	2

* 2-on-1 shade will double the quantity of handles.

* 3-on-1 shade will triple the quantity of handles.

TOOLS AND PARTS YOU MAY NEED (not included)

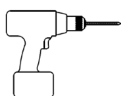

Drill with bits



Metal tape measure



Pen



#4 x 3/4" flat head wood screw



Screwdriver

FOR THE 3/4" RAIL BRACKETS

1. Install the brackets

- Mark the bracket locations, separating the brackets evenly. Make sure all brackets are aligned and level with each other.
- For inside mount - Install the bracket with the hole at top center by using the included screw or with two holes at the top rear side by using #4 x 3/4" flat head wood screws (not included).
- For outside mount - install the bracket with two holes at the back side with included screws.

- Fasten the screws completely.
- Install the shade with the extension brackets (optional)
 - Install the extension bracket with at least 2 screws.
 - Attach the mounting brackets to the extension brackets with the screws.

Use #4 x 3/4" flat head wood screws (not included) for these two holes

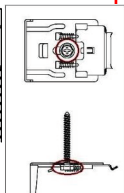
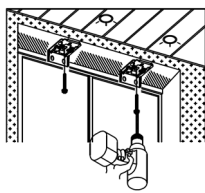

Inside Mount

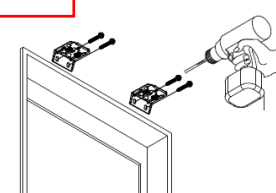
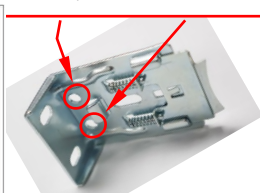

Outside Mount

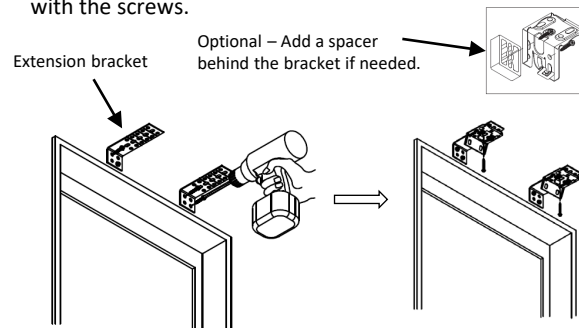

Optional - Add a spacer behind the bracket if needed.

2. Attach the cell shade

- Position the headrail with the front lip resting on the top hooks of all the brackets.
- Push the bottom of headrail firmly upward and toward the window until the groove at the bottom of the headrail snaps into place.

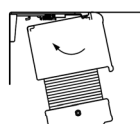
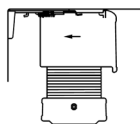

Mounting spaces

- Minimum mounting space - 1/2"
- Flush mounting space
 - 2-1/4" for 9/16" and 7/16" fabrics
 - 2-1/2" for 3/4" fabrics
 - 2-7/8" for 1-1/4" fabrics

3. How to remove the shade from the brackets

- Raise the shade completely. Push the headrail toward to the wall.
- Tilt the backside of the headrail down
- Once the back of the headrail clears the brackets, pull the headrail off the front of brackets.

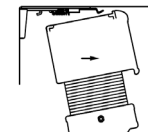
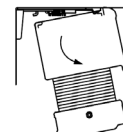
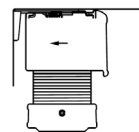

WARNING/ADVERTENCIA

Window blind cord can STRANGLE your child.
To prevent strangulation, purchase cordless products or products with inaccessible cords.

La cuerda de la persiana puede ESTRANGULAR a su niño.
Para evitar el estrangulamiento, compre alternativas cuerda o productos con cuerdas inaccesibles.

Cordless Top Down Bottom Up and Day/Night Cellular Shade Installation Instruction

FOR 9/16" RAIL BRACKETS

1. Install the brackets

- Mark the bracket locations, separating the brackets evenly. Make sure all brackets are aligned and level with each other.
- For inside mount - Install the bracket with the holes at top by using the included screws.
- For outside mount – install the bracket with the holes at the back side with included screws.

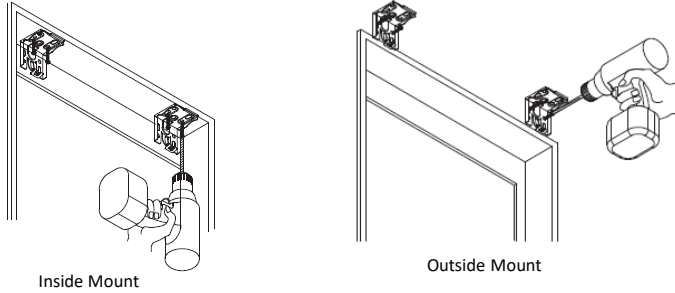

- Fasten the screws completely.
- Install the shade with the extension brackets (optional)
 - Install the extension bracket with at least 2 screws.
 - Attach the mounting brackets to the extension brackets with the screws.

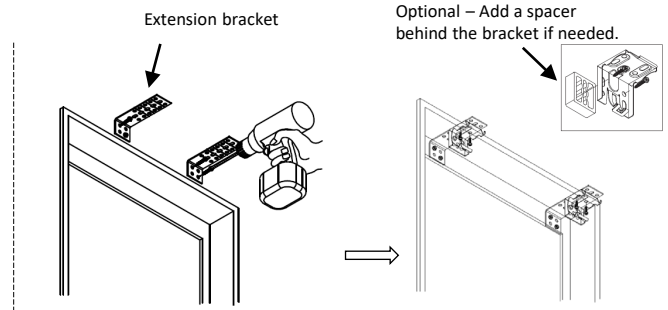

2. Attach the cell shade

- Position the headrail with the front lip resting on the top hooks of all the brackets.
- Push the bottom of headrail firmly upward and toward the window until the groove at the bottom of the headrail snaps into place.

Mounting spaces

- Minimum mounting space – 7/8"
- Flush mounting space
 - 2" for 9/16" and 7/16" fabrics
 - 2-1/8" for 3/4" fabrics
 - 2-1/2" for 1-1/4" fabrics

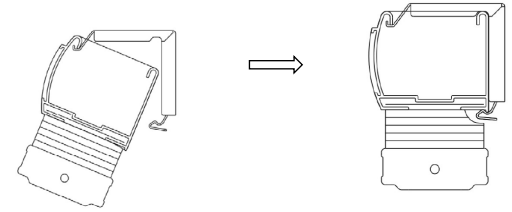

3. How to remove the shade from the brackets

- Raise the shade completely.
- Use a flat screw to push the bracket tab toward the wall. Once you hear a "click", then the shade will be released from the bracket.
- Repeat above step to release the shade from other brackets.

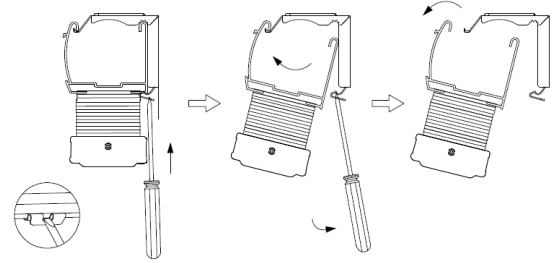

INSTALL THE HOLD DOWN BRACKETS (optional)

- Install the hold down brackets with screws at each side when needed.

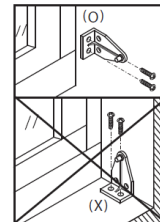

Hold down bracket (optional)

ATTACH PULLING HANDLES AND OPERATE THE SHADE

- Attach pulling handles evenly to the middle and bottom rails.
- Pull the middle rail down or push it up to adjust the location of the middle rail.
- Pull the bottom rail down to lower the cellular shade or push the bottom rail up to raise the cellular shade.
- To raise the entire shade, push the middle rail up first, and then the bottom rail.

NOTE. Please allow 24 hours for your shade to drop to its actual height when first installed due to the nature of the fabric.