

# Simple Touch® Wand Cellular Shade

## - Installation Instruction

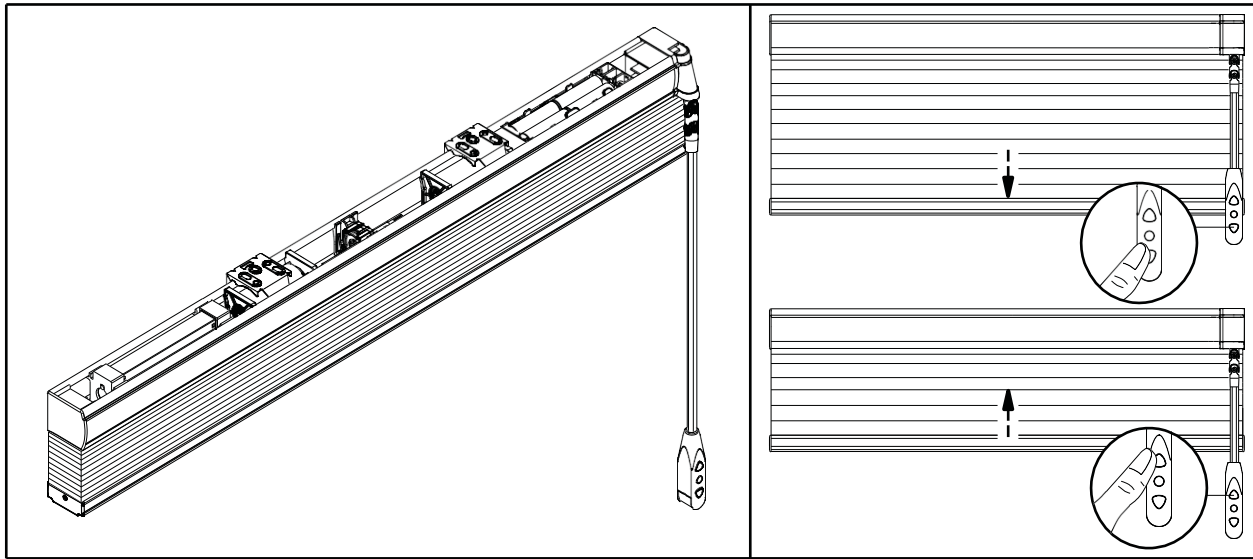

Press the **DOWN** button to lower the shade.

Press the **UP** button to raise the shade.

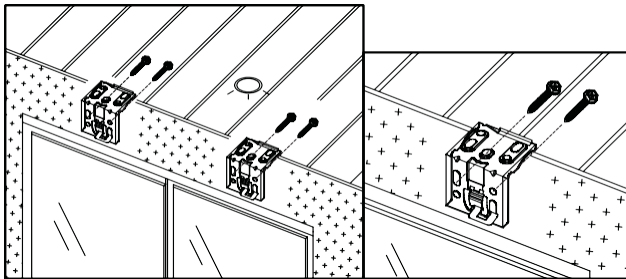

Fig(1-1)

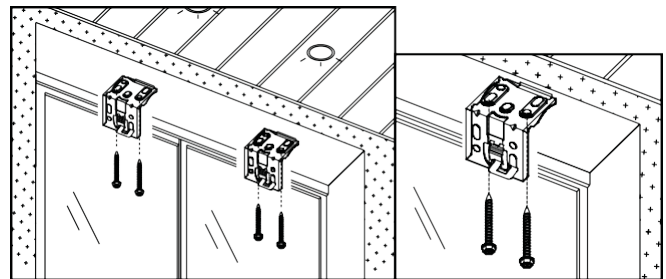

Fig(1-2)

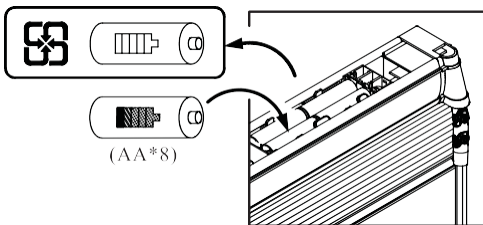

Fig(2)

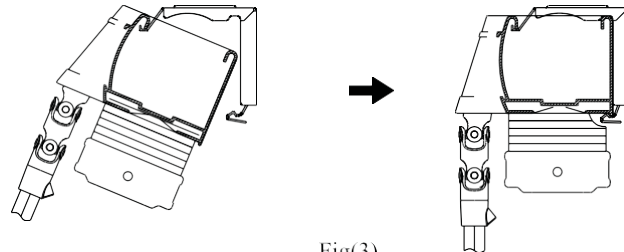

Fig(3)

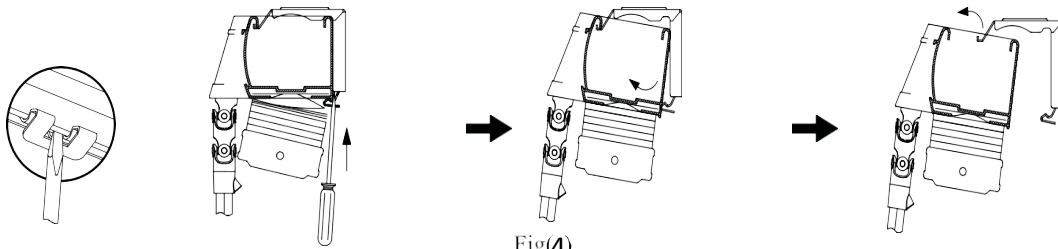

Fig(4)

1. Find location on the headrail where brackets go on the shade.
2. Mark the bracket location on the window fixture.
3. Fasten the brackets on the fixture. (Fig 1)
4. Put 8 AA batteries inside the battery box. (Fig 2).
5. Mount the shade onto the brackets. (Fig 3)
6. To change the batteries, remove the shade from the brackets. (Fig 4)
7. Replace with new batteries (do not mix new batteries with used batteries. Mount the shade.

Shade width	Qty of brackets
$W \leq 36"$	2
$36" < W \leq 48"$	3
$48" < W \leq 72"$	3
$72" < W \leq 96"$	4
$96" < W \leq 120"$	5

Complimentary Alkaline batteries are included. If the shade is installed in the warm and humid space, please use Lithium batteries for better performance.

# Simple Touch® Wand Cellular Shade

## - Programming & Operation Instruction -





This Simple Touch® Wand motorized shade is already programmed with Up and Bottom Limits. Option to program “My Favorite Position” followed with the instruction below. Enjoy your new motorized shade!

### Set up My Favorite Position



Operate the shade to your favorite position

Press “**My Favorite**” button for 5 seconds until you hear  B -

Press “**My Favorite**” button again for 3 seconds, then hear  B - - -

Set up “**My Favorite Position**” is done.

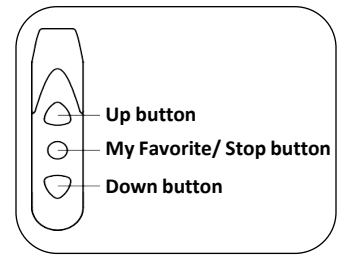

To reprogram this motorized shade, please follow the steps below.

### Set Clear



Press all 3 buttons at same time until you hear a long  B -

“Clear” is done.

### Set up Upper Limit



Press and hold “**Up**” button to move the shade to Upper limit.

Press “**Up**” & “**My Favorite**” buttons at the same time for 5 seconds.

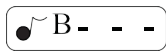

Set up “**Upper Limit**” is done.

### Set up Bottom Limit



Press and hold “**Down**” button to move the shade to Bottom limit.

Press “**Down**” & “**My Favorite**” buttons at the same time for 5 seconds.

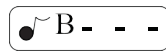

Set up “**Bottom Limit**” is done.

## Operation Instruction

### Before setting the limits

- Shade can only operate by pressing the buttons
- “My Favorite” button can only Stop the moving of the shade.

### After setting the limits

- Press **Up** or **Down** button for 2 seconds, the shade will operate without pressing the buttons
- Press “**My Favorite**” button for 1 second, the shade will operate to the Favorite position.
- Press any button to stop the moving.
- To change “**My Favorite Position**”, please follow step “**Set Clear**”, “**Set up Upper Limit**”, “**Set up Bottom Limit**”, and then “**Set up My Favorite Position**”.